

2x

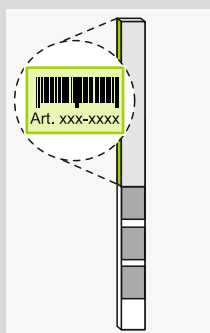

min. 1.5 h

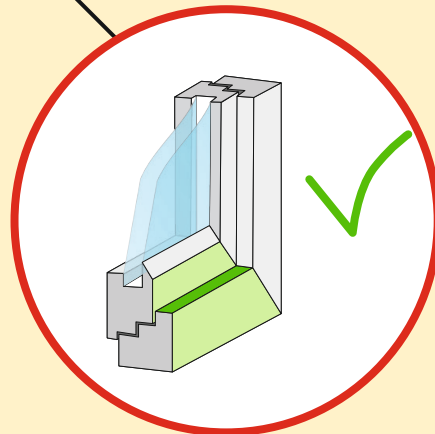

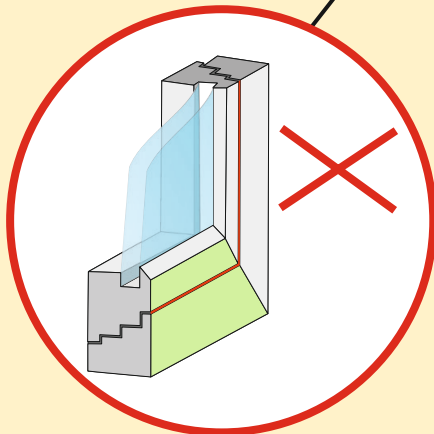
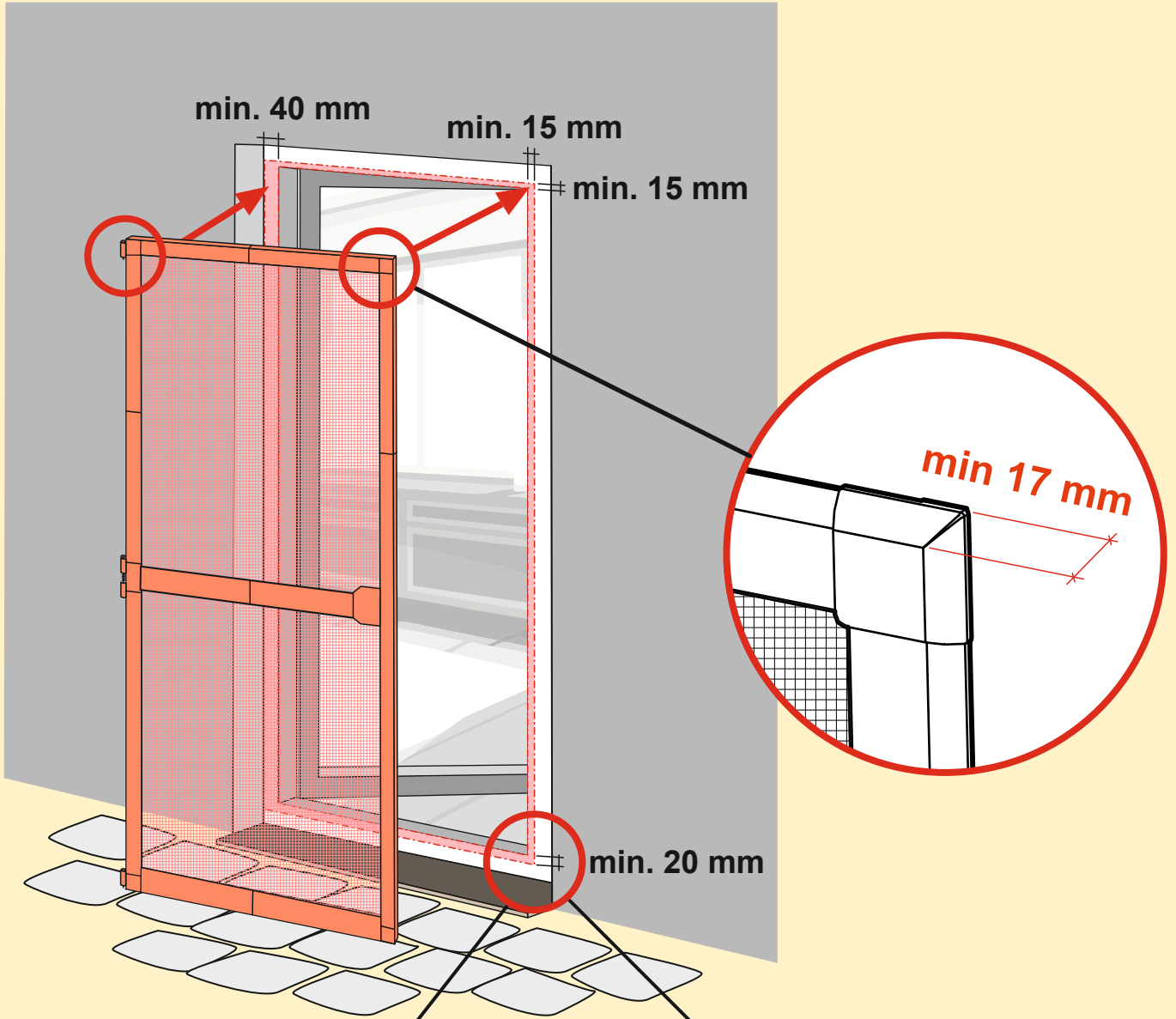
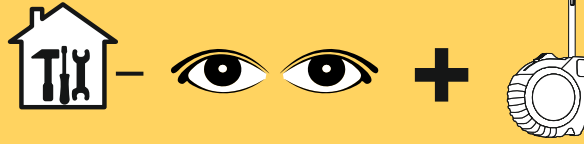

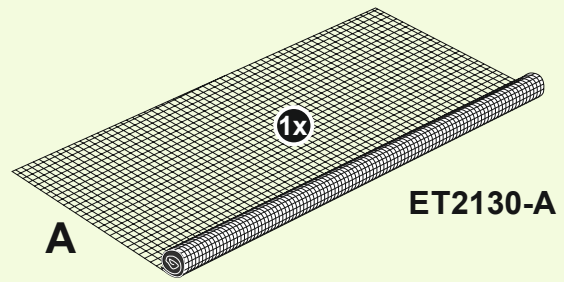
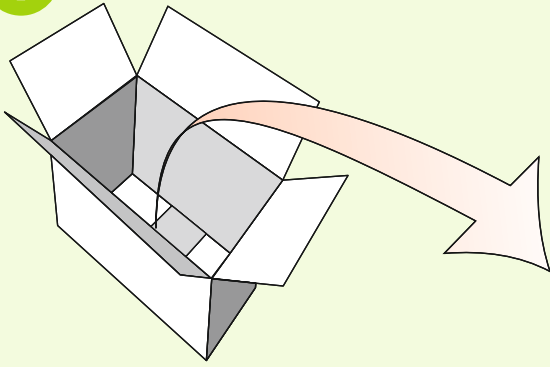

A

ET2130-A

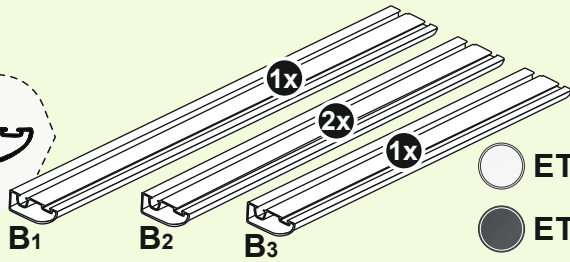
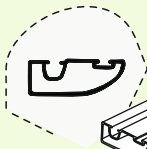

B1

B2

B3

ET2130-B 1/2/3

ET2132-B 1/2/3

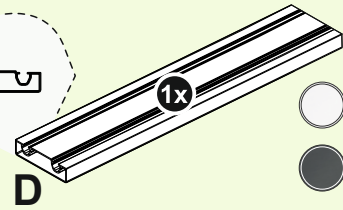
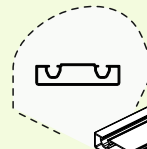

D

ET2130-D

ET2132-D

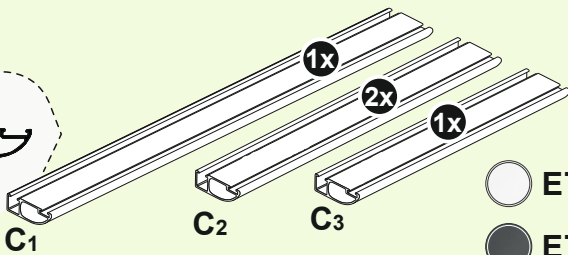

C1

C2

C3

ET2130-C 1/2/3

ET2132-C 1/2/3

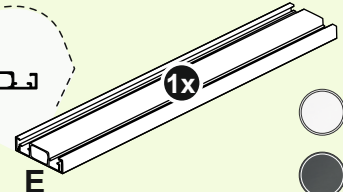
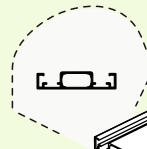

E

ET2130-E

ET2132-E

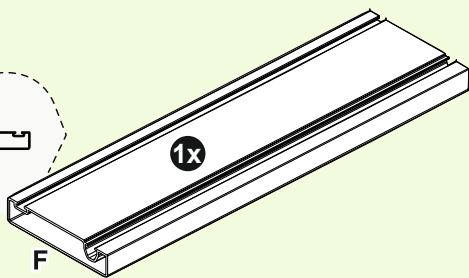
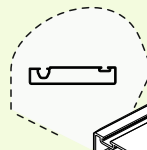

F

ET2130-F

ET2132-F

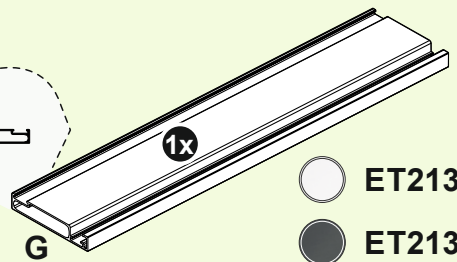
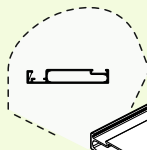

G

ET2130-G

ET2132-G

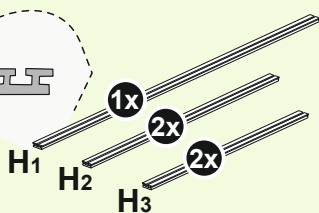
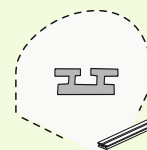

H1

H2

H3

ET2130-H 1/2/3

ET2132-H 1/2/3

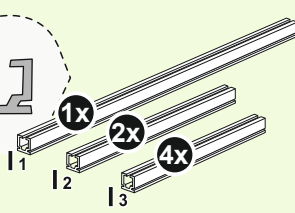
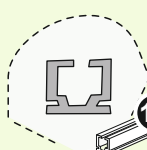

I1

I2

I3

ET2130-I 1/2/3

ET2132-I 1/2/3

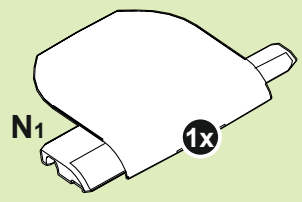
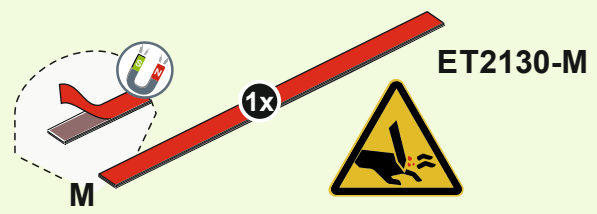
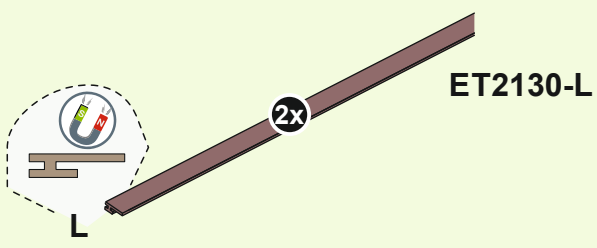
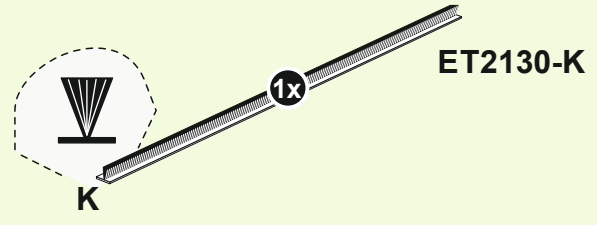
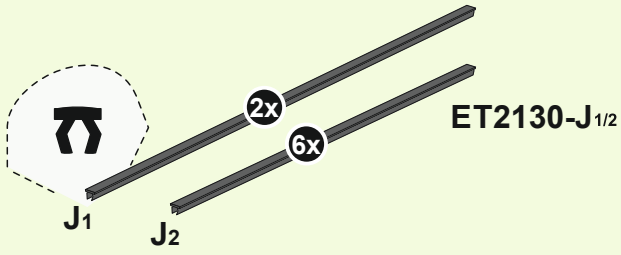

- ET2130-N₁
- ET2132-N₁

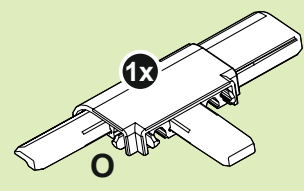

- ET2130-O
- ET2132-O

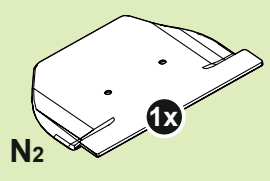

- ET2130-N₂
- ET2132-N₂

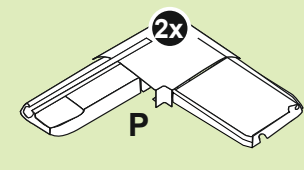

- ET2130-P
- ET2132-P



- ET2130-N₃



- ET2130-S
- ET2132-S

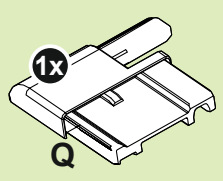

- ET2130-Q
- ET2132-Q



- ET2130-T
- ET2132-T

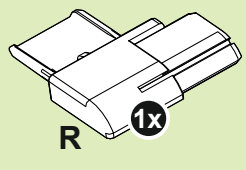

- ET2130-R
- ET2132-R

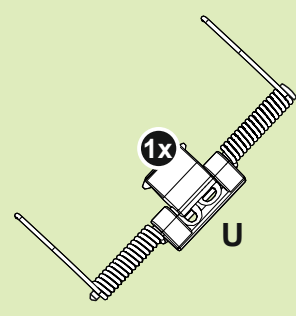

- ET2130-U
- ET2132-U

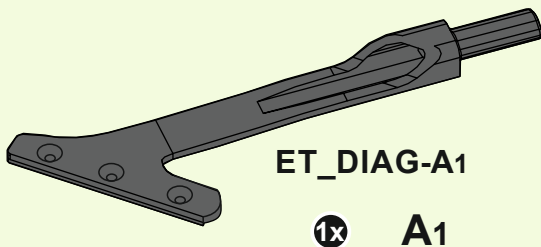
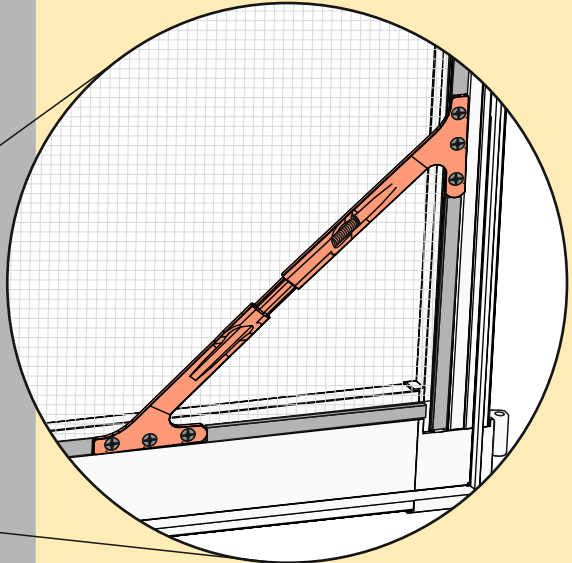
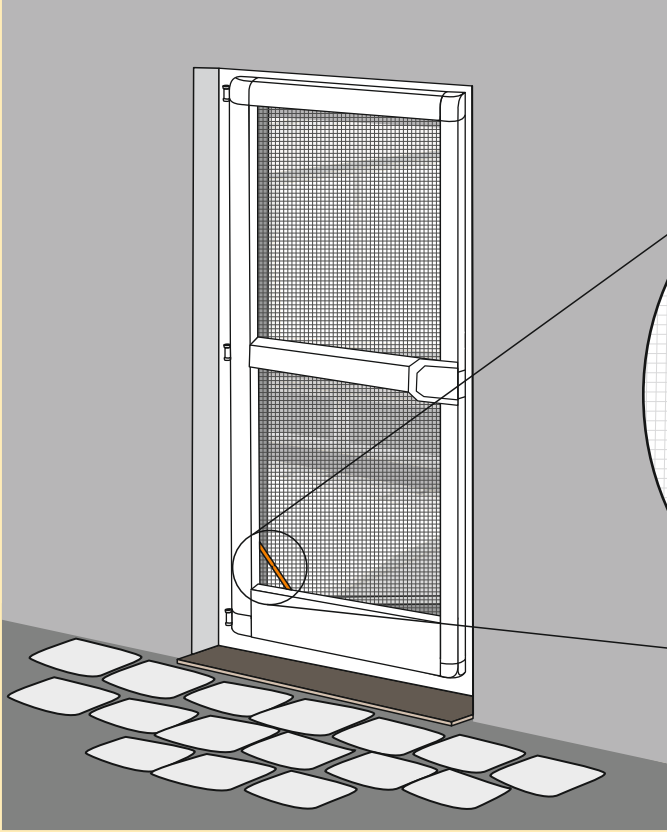

ET_DIAG-A1

1x A1

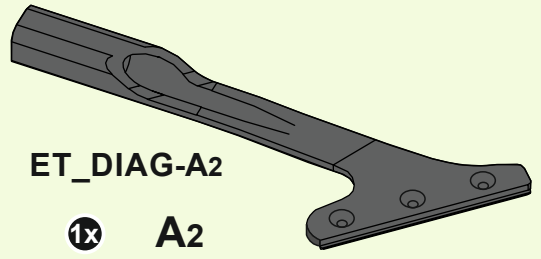

ET_DIAG-A2

1x A2

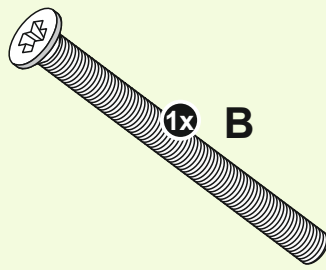

1x B

ET_DIAG-B

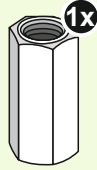

1x C

ET_DIAG-C



6x D

ET_DIAG-D

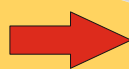
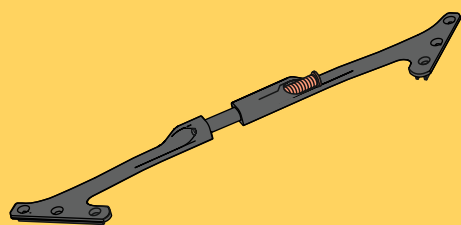

1

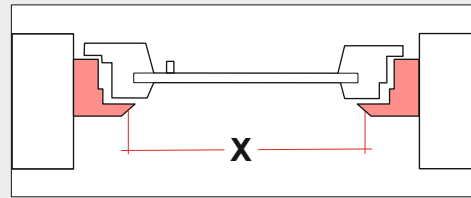
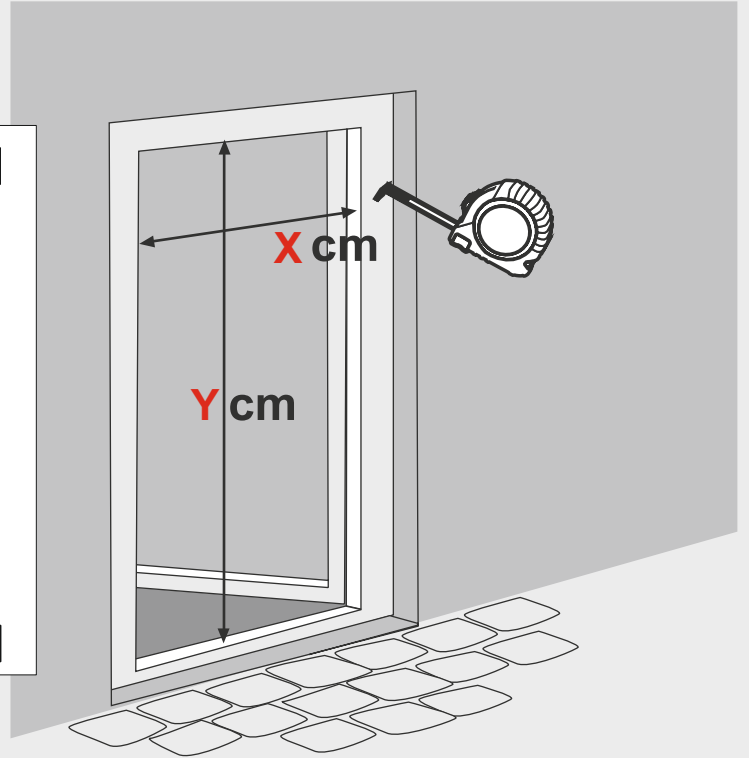
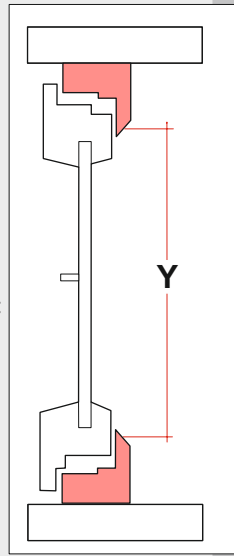
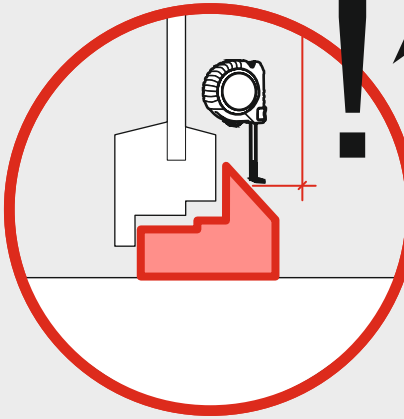
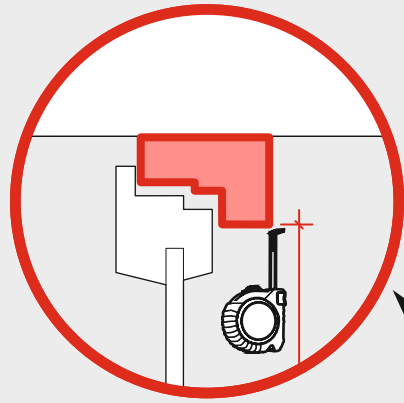
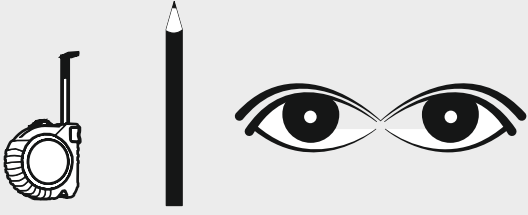

Y = _____ cm

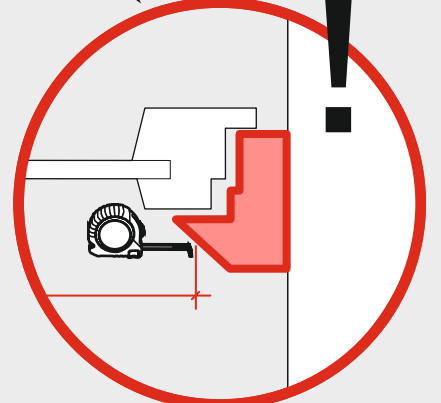
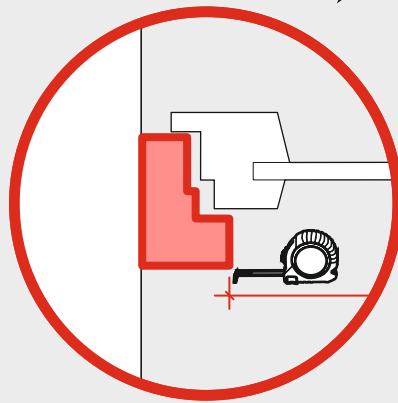

X = _____ cm



2 → 26

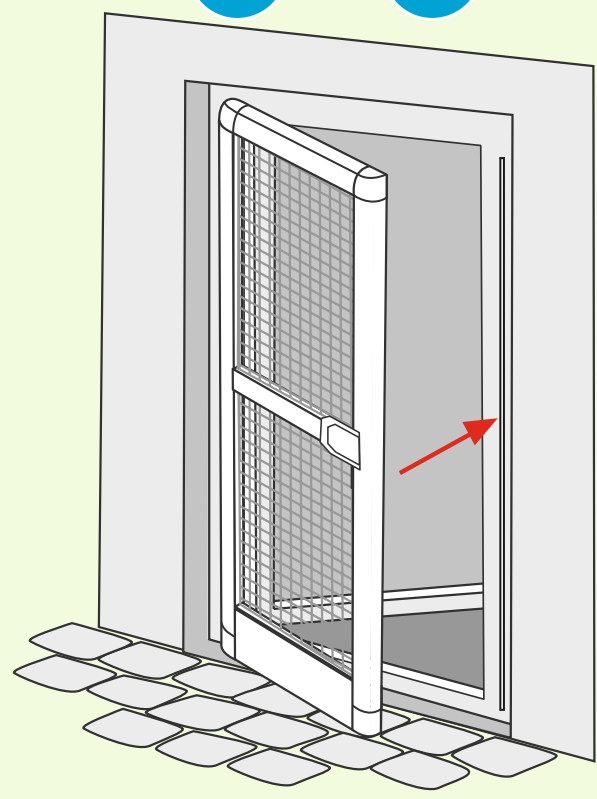

27 → 51

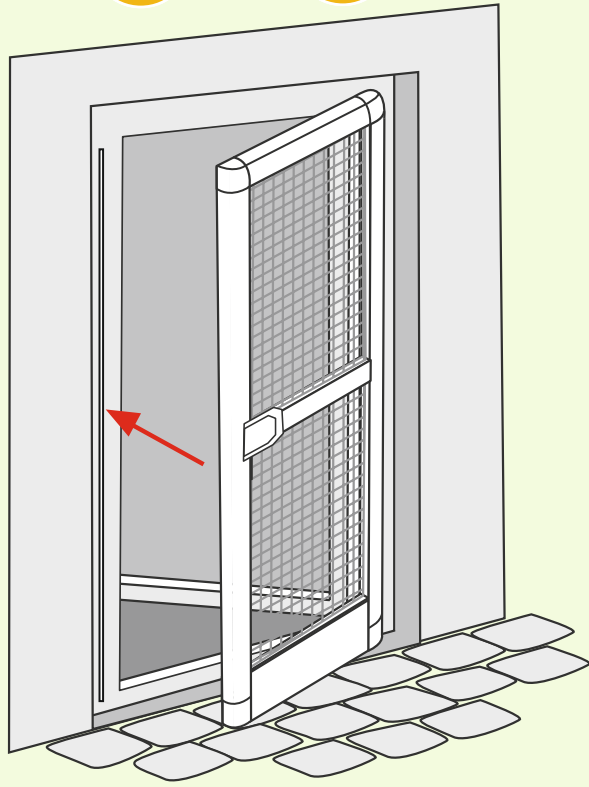

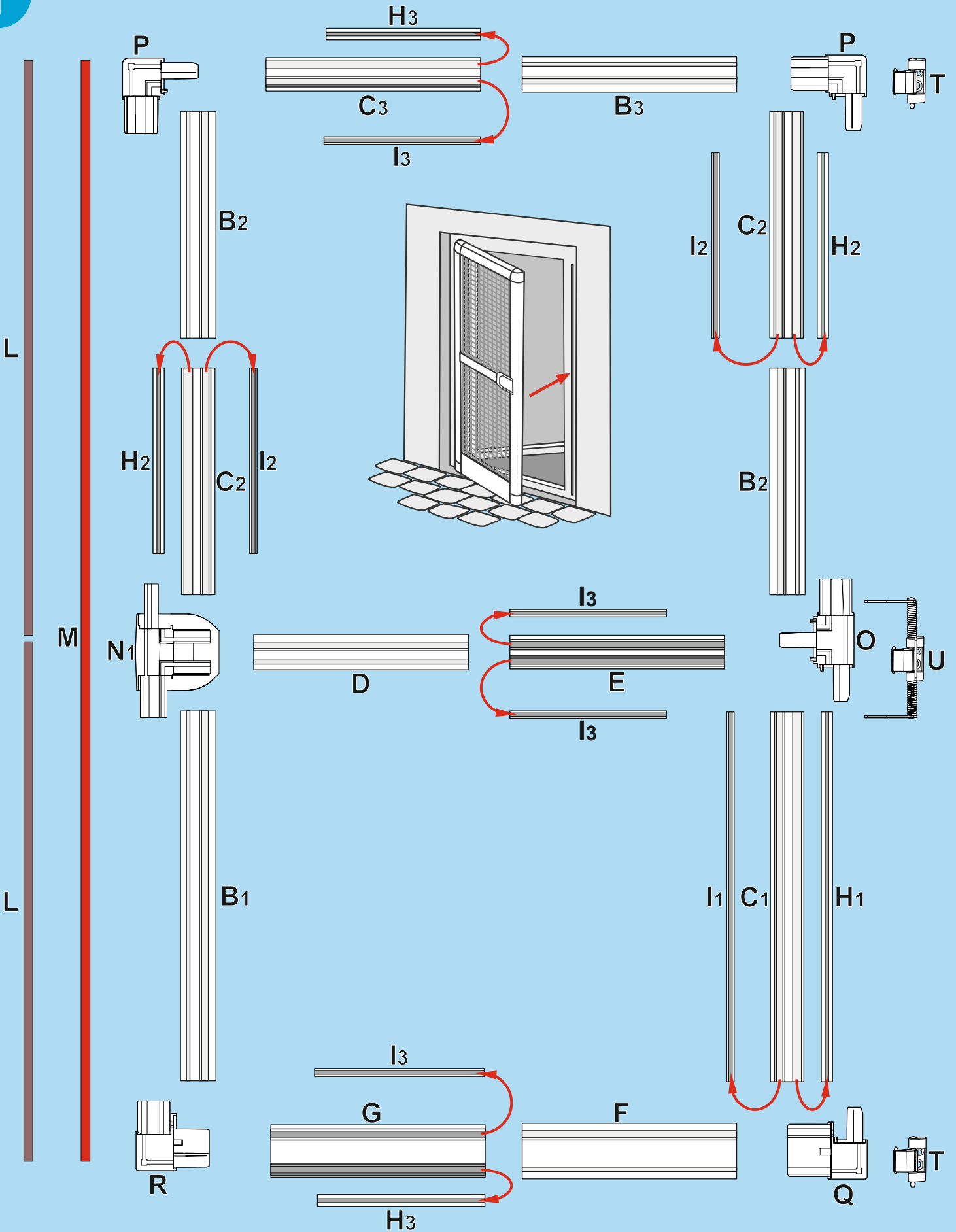
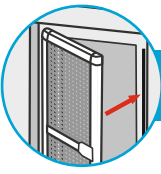

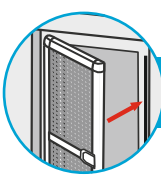

2

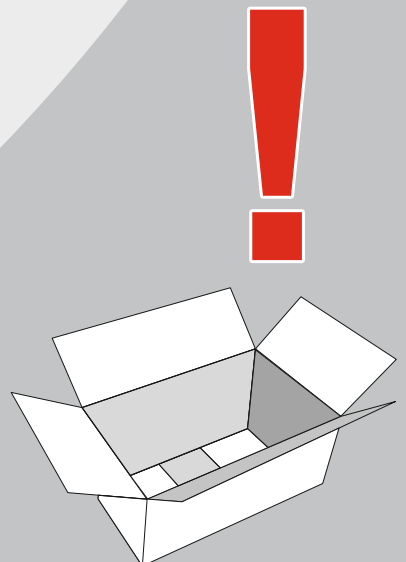
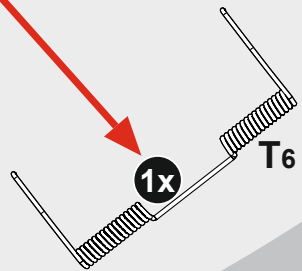
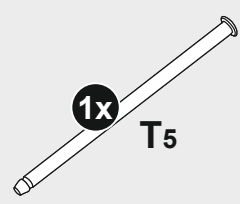
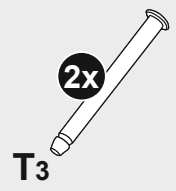
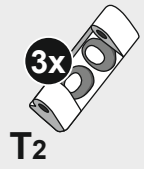
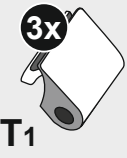
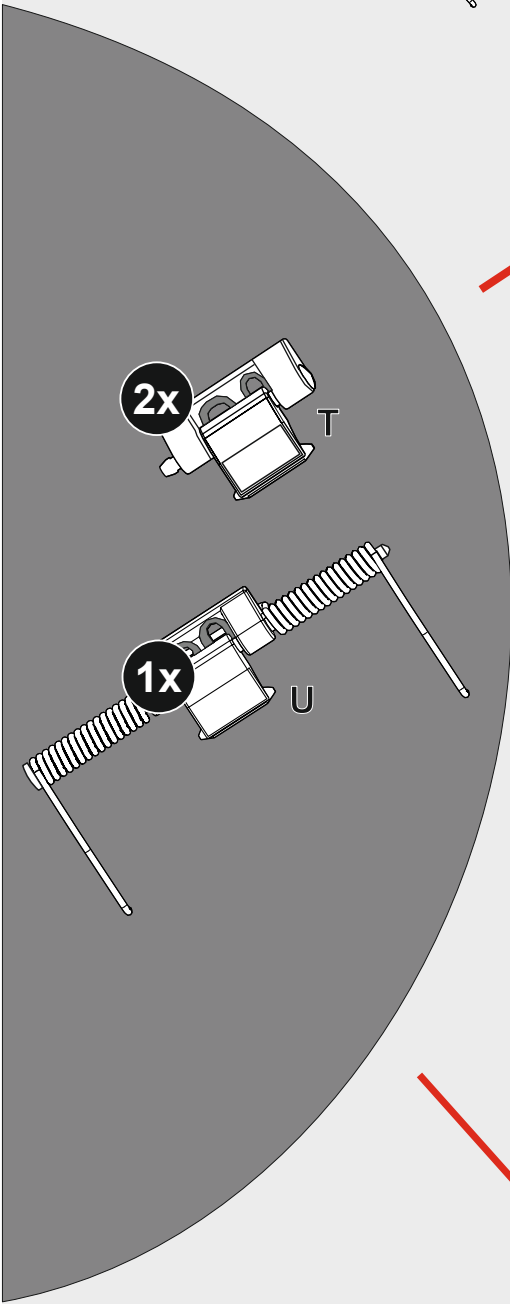
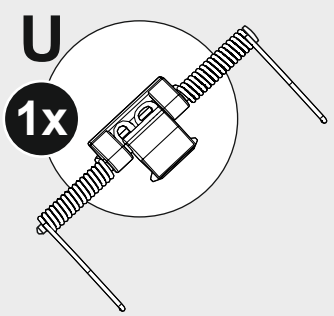
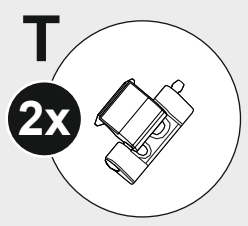

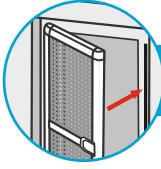

3

- P**
1x
- Q**
1x
- O**
1x
- T1**
3x
- S**
1x

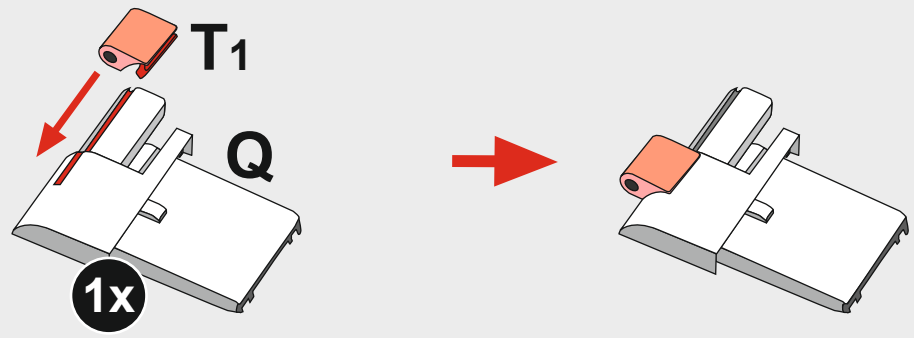
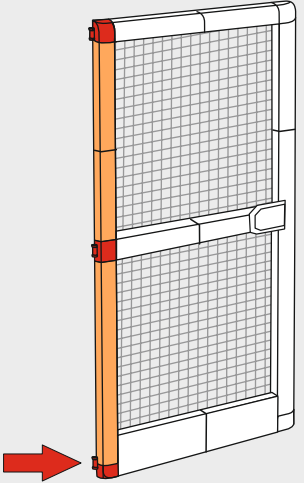
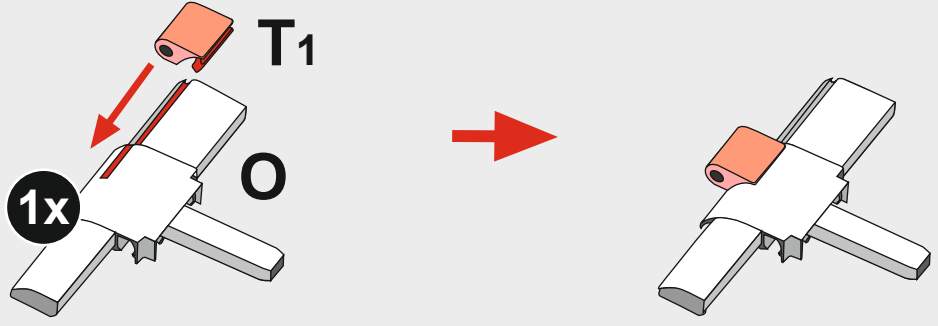
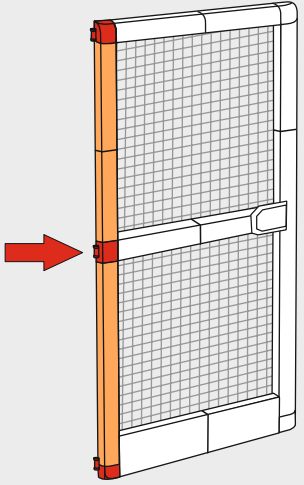
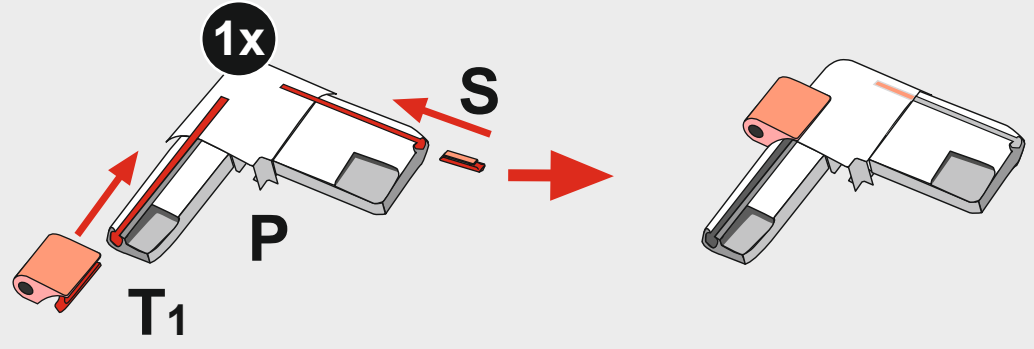
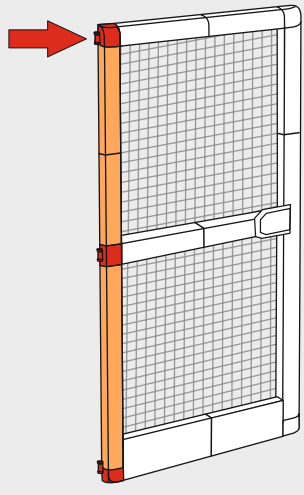

2 → 26

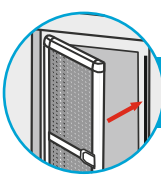

4

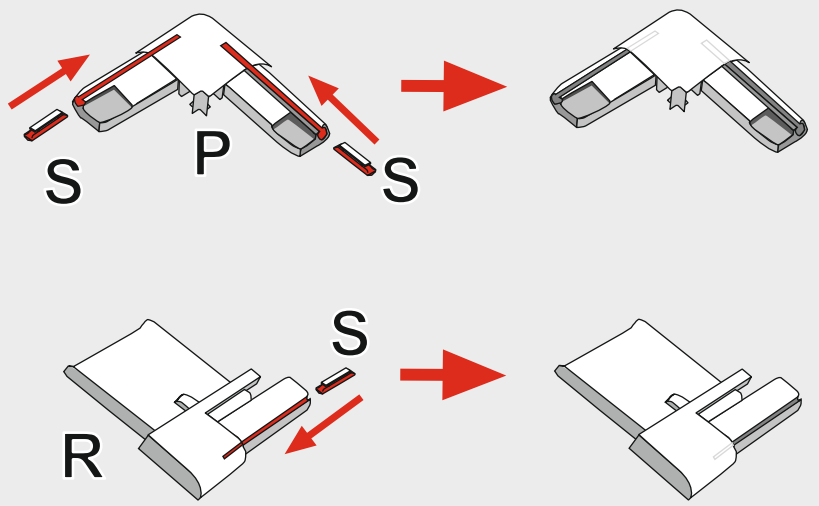
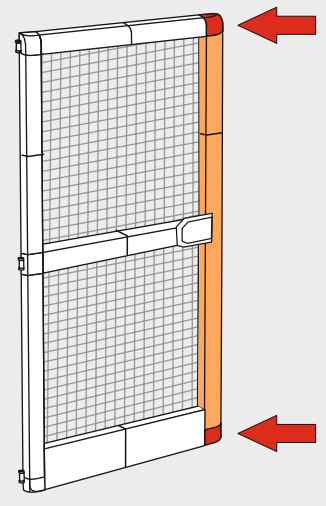
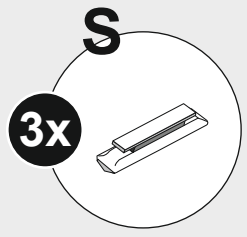
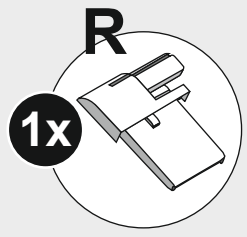
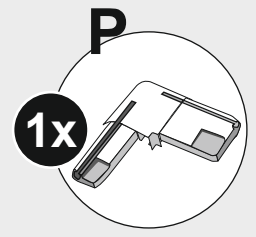

5

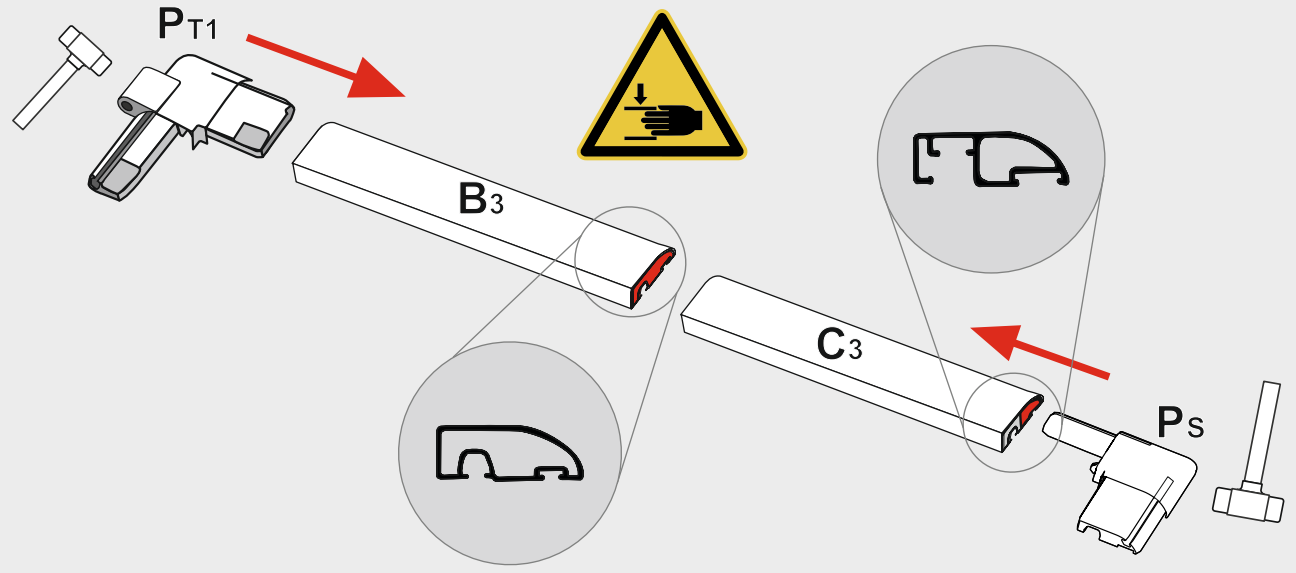
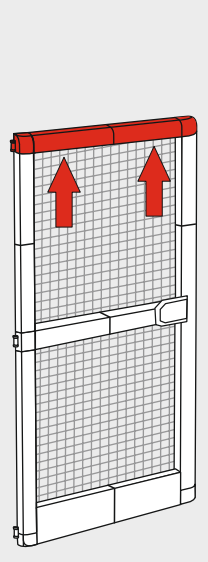
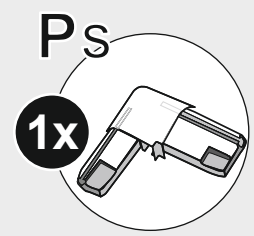
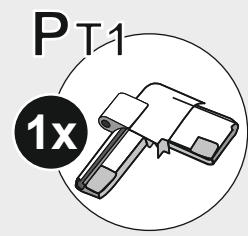
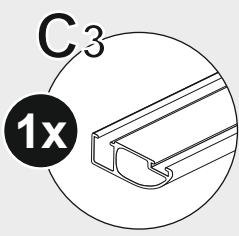
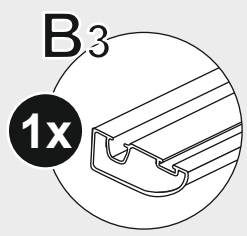
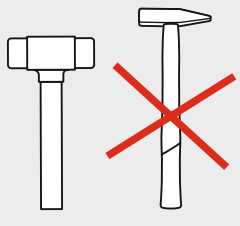

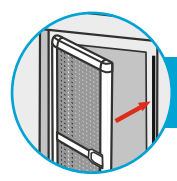

2 → 26

6

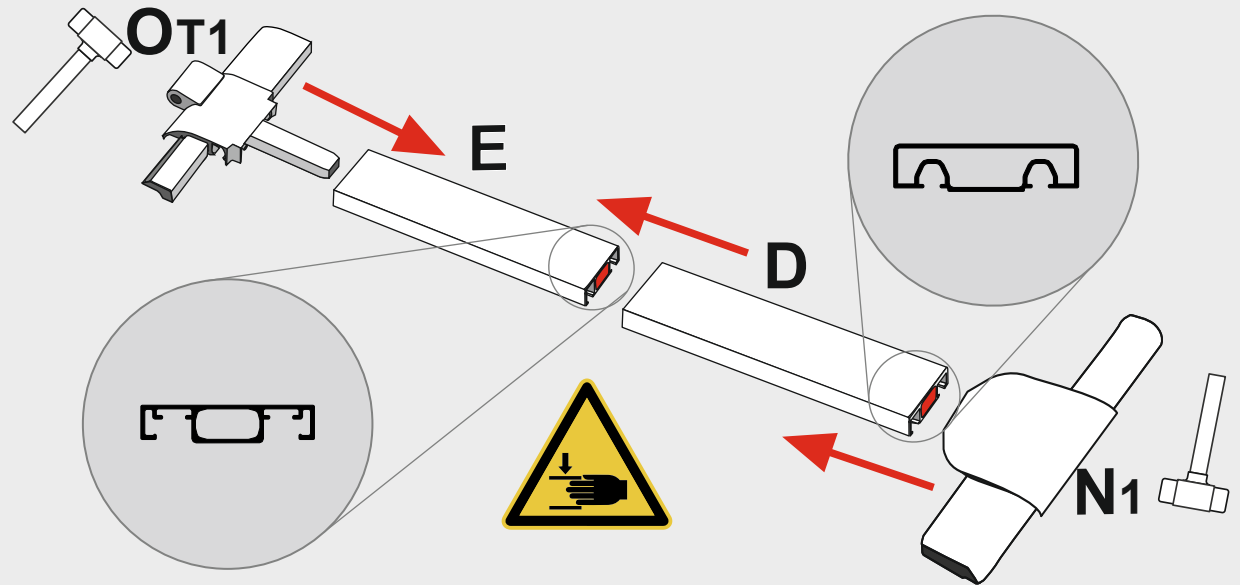
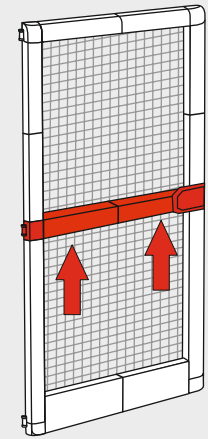
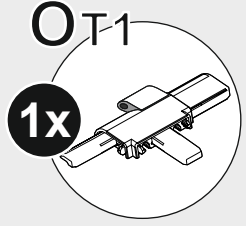
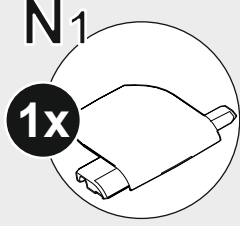
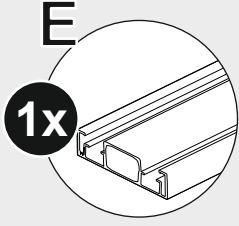
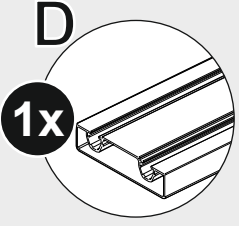
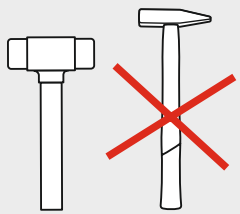

7

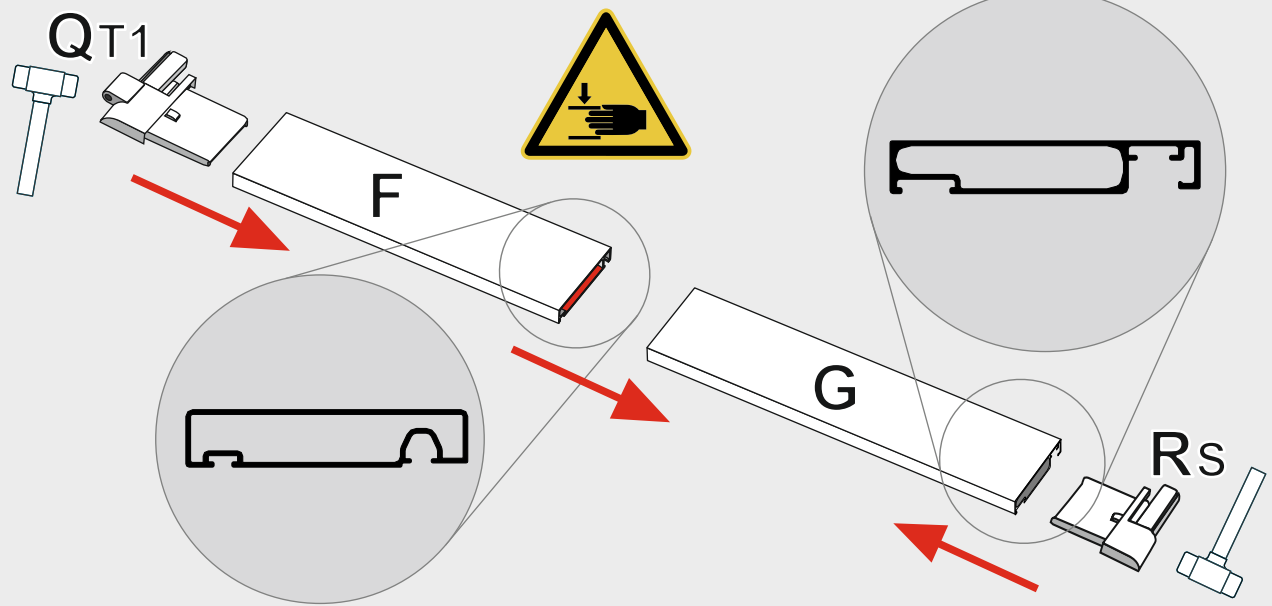
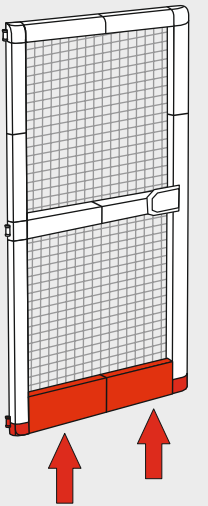
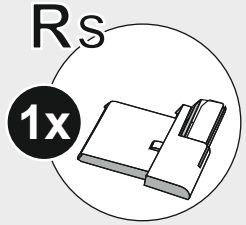
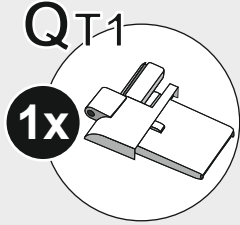
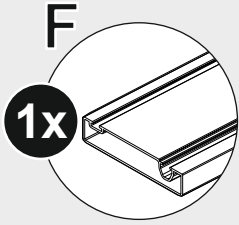
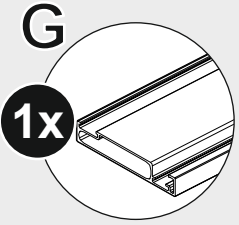
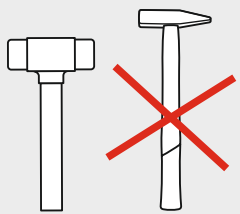

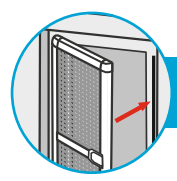

2 → 26

8

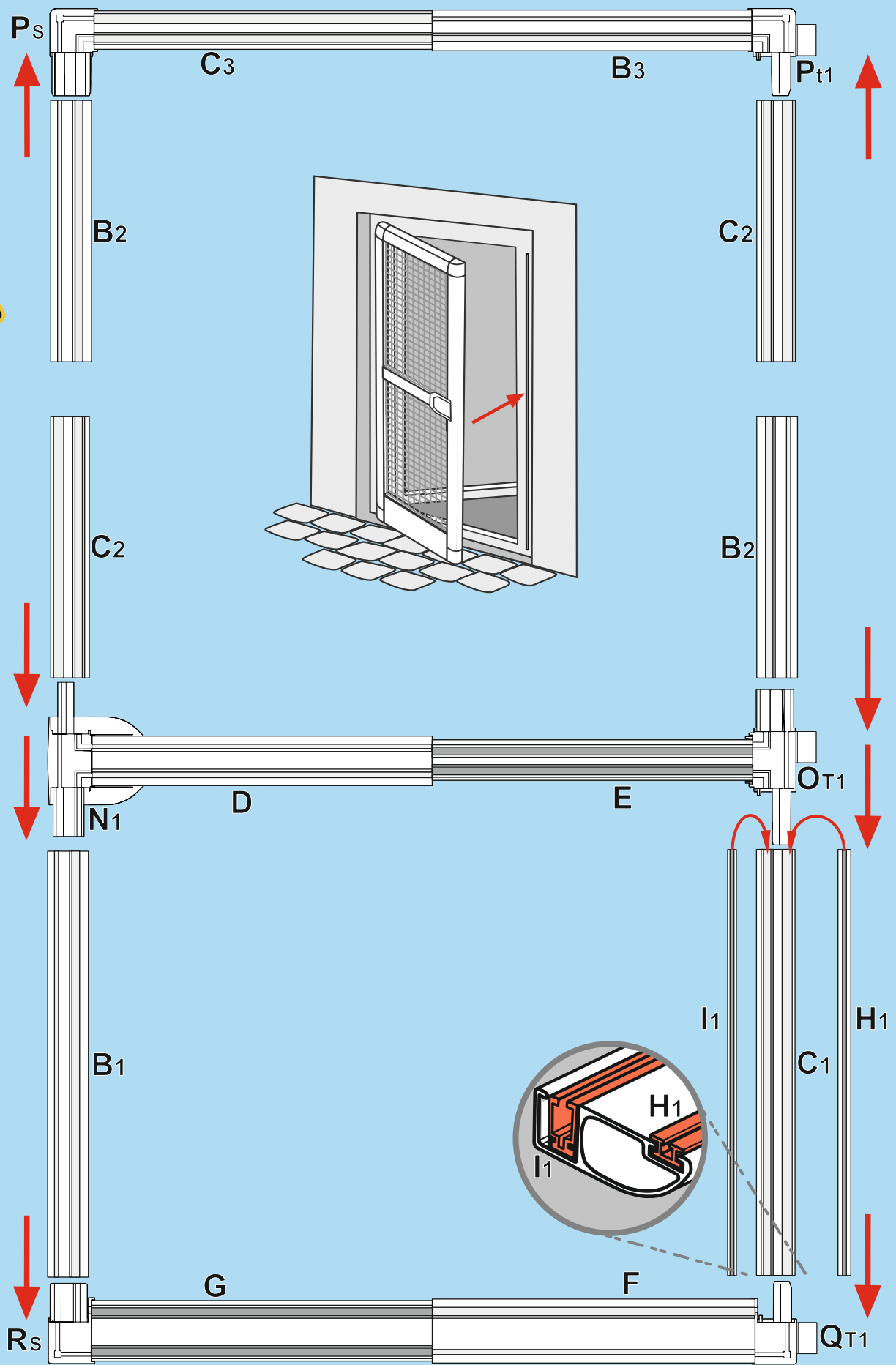

9

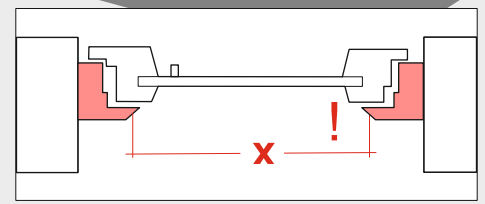
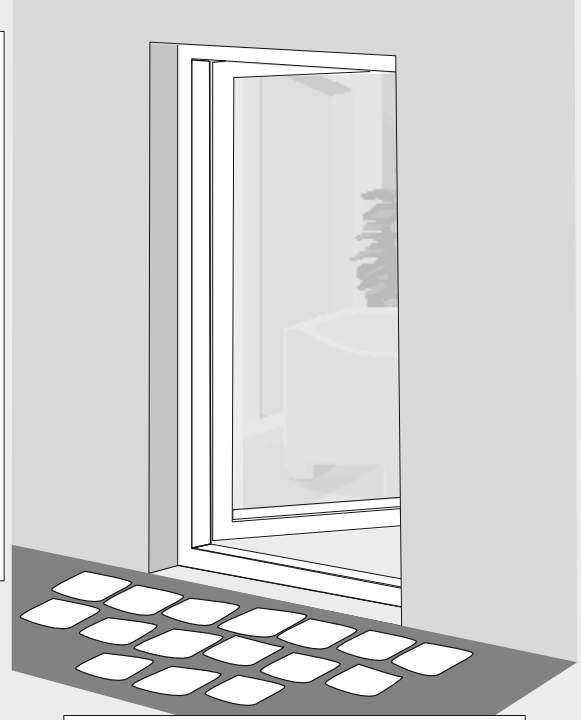
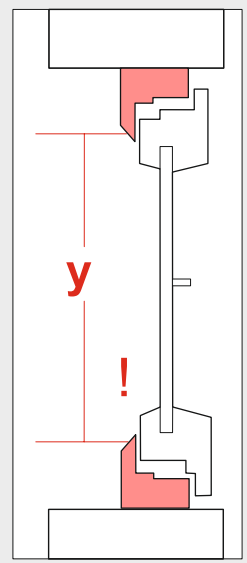
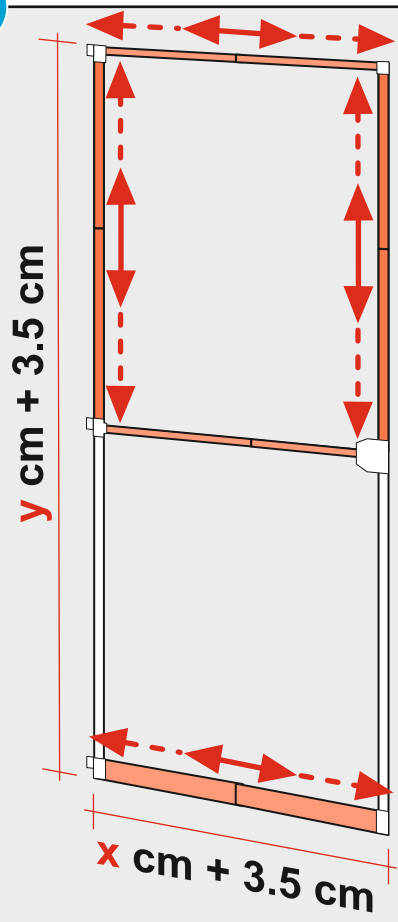

10

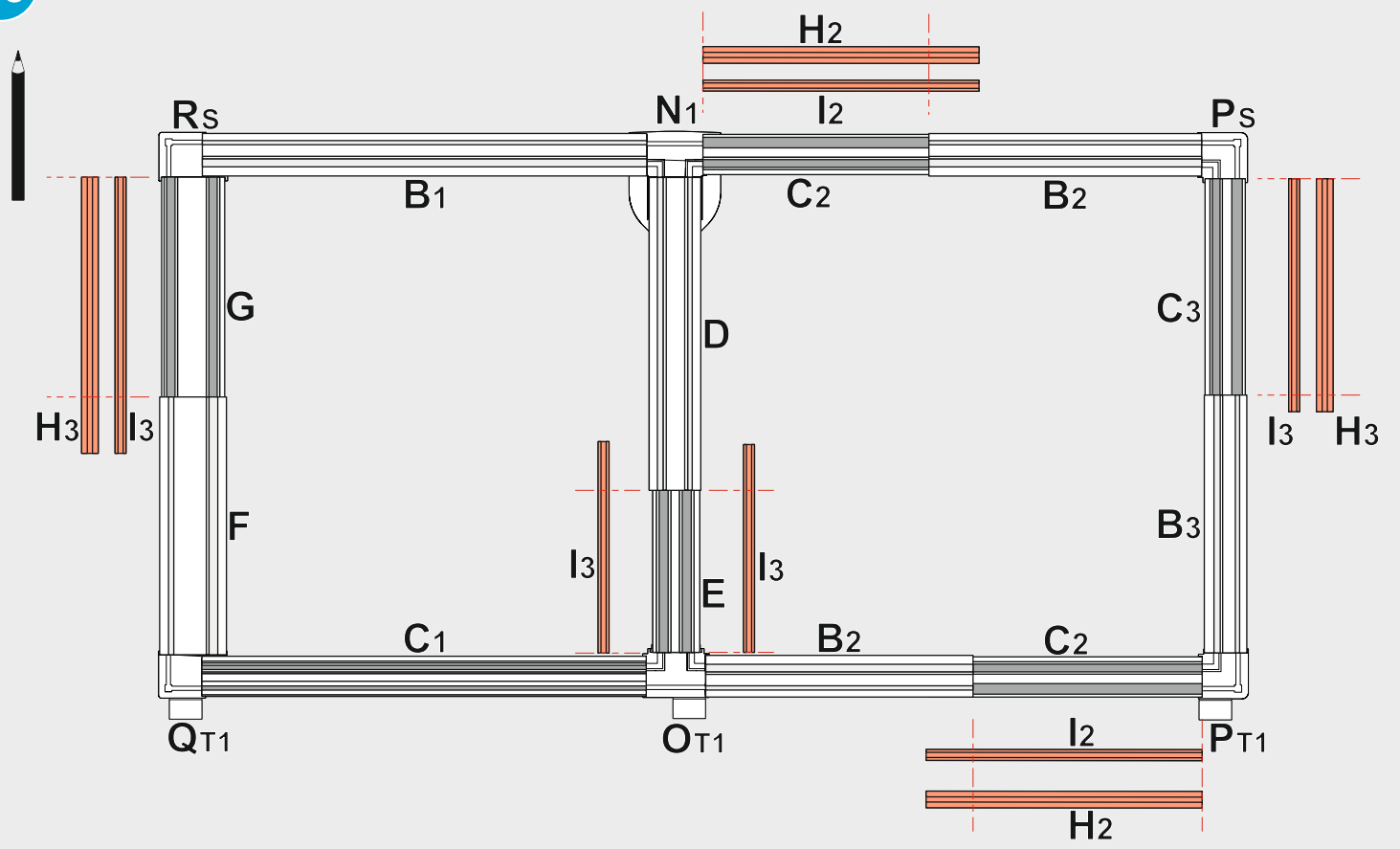

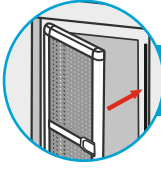

2 → 26

11

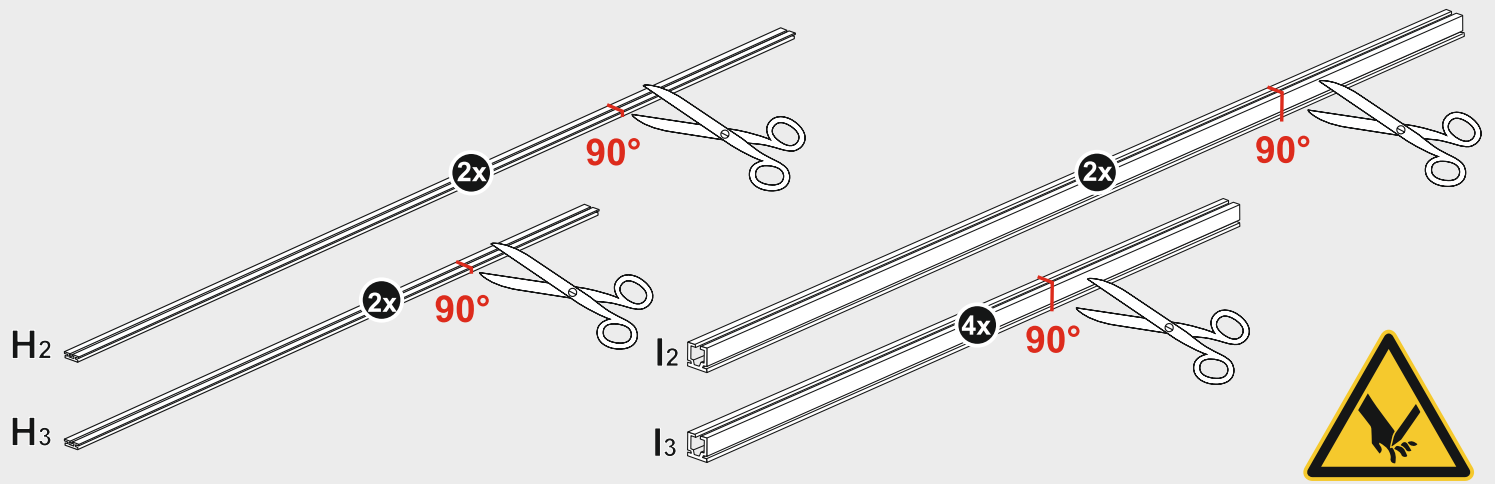
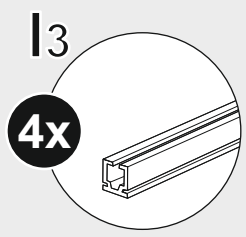
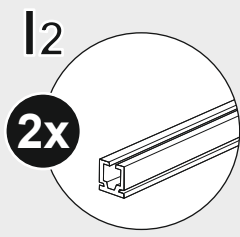
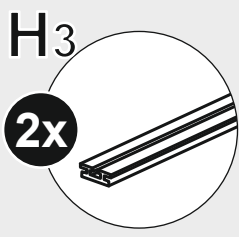
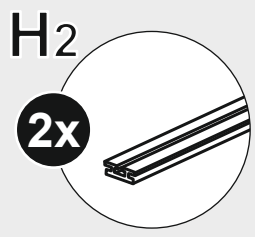
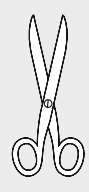

12

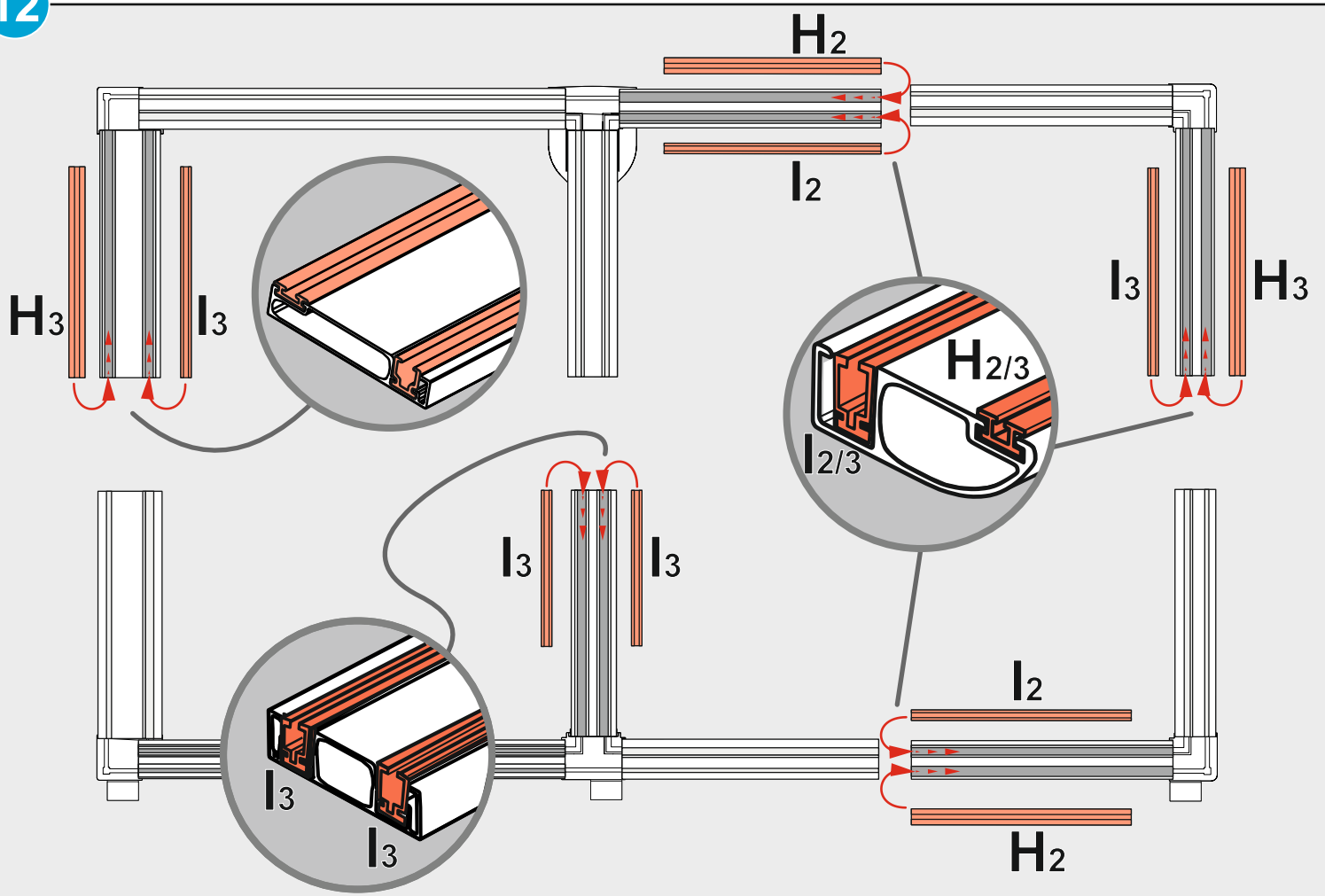

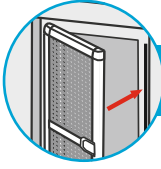

2 → 26

13

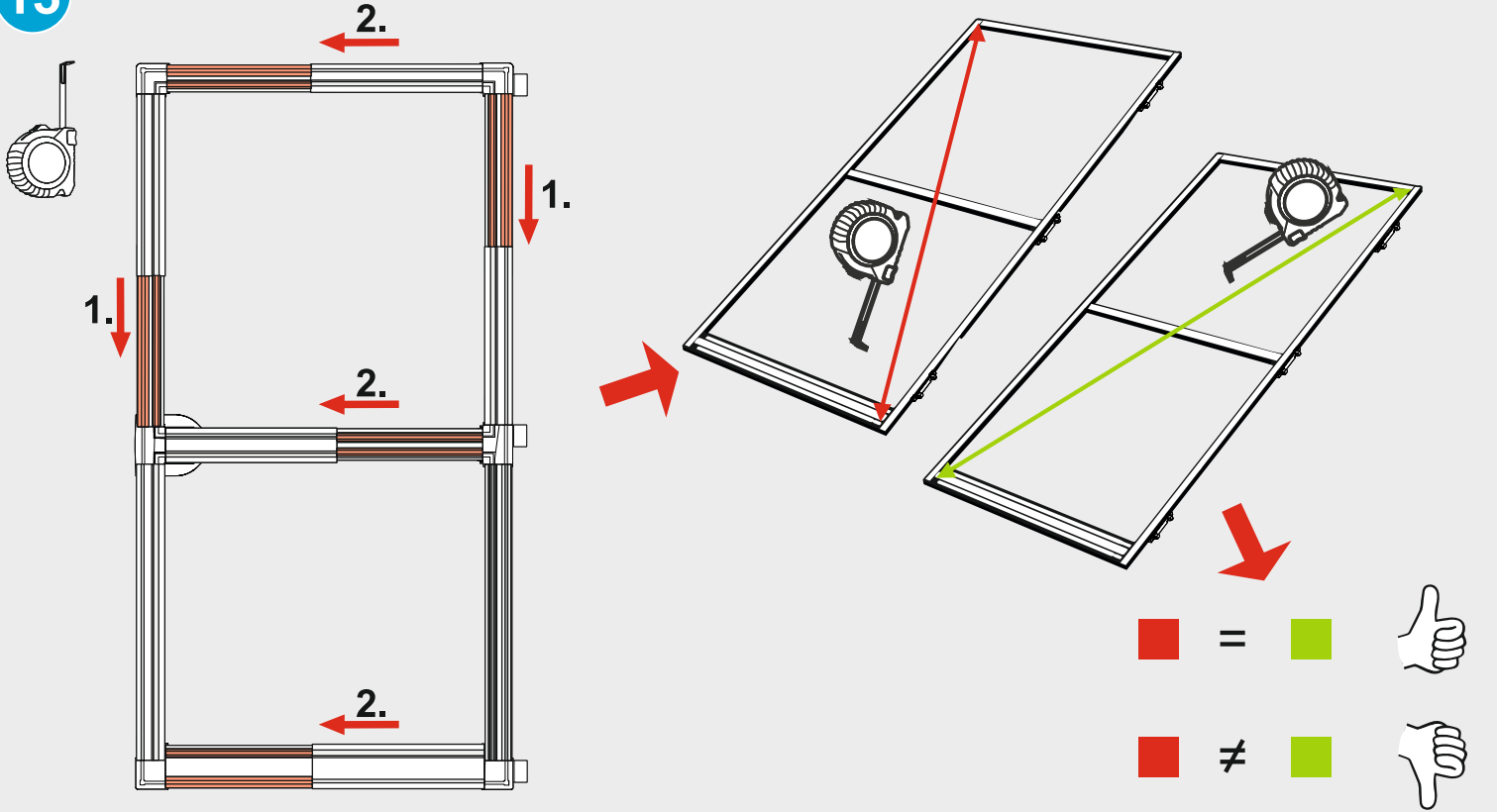

14

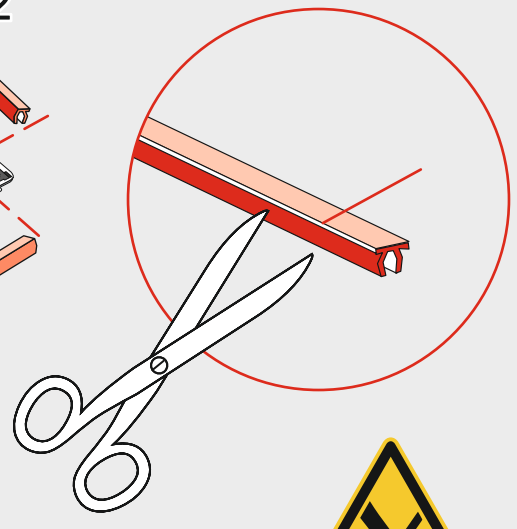
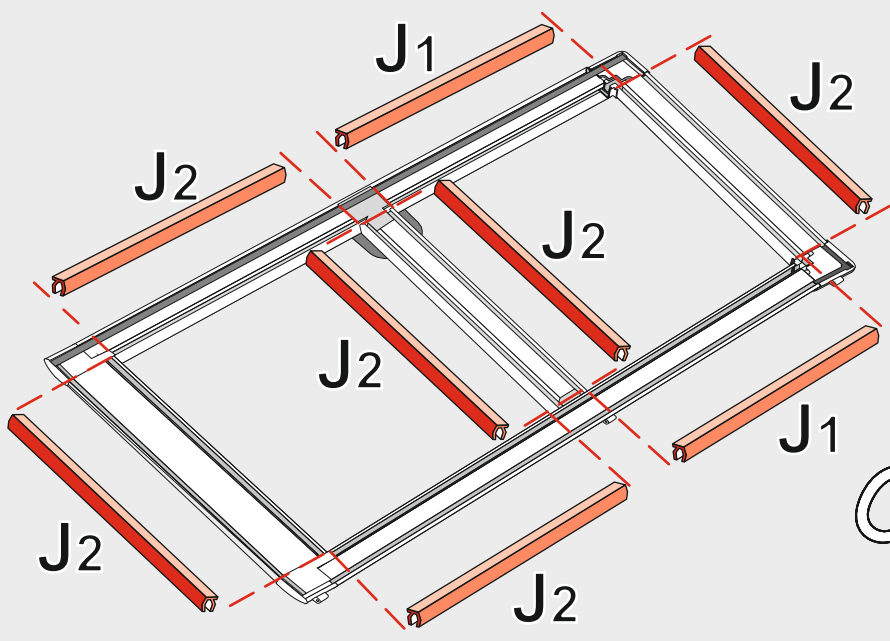
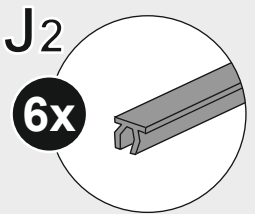
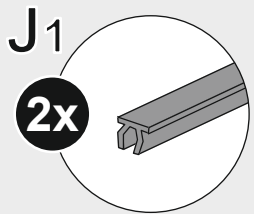
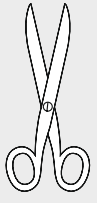

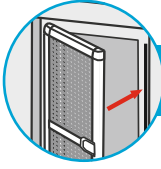

2 → 26

15

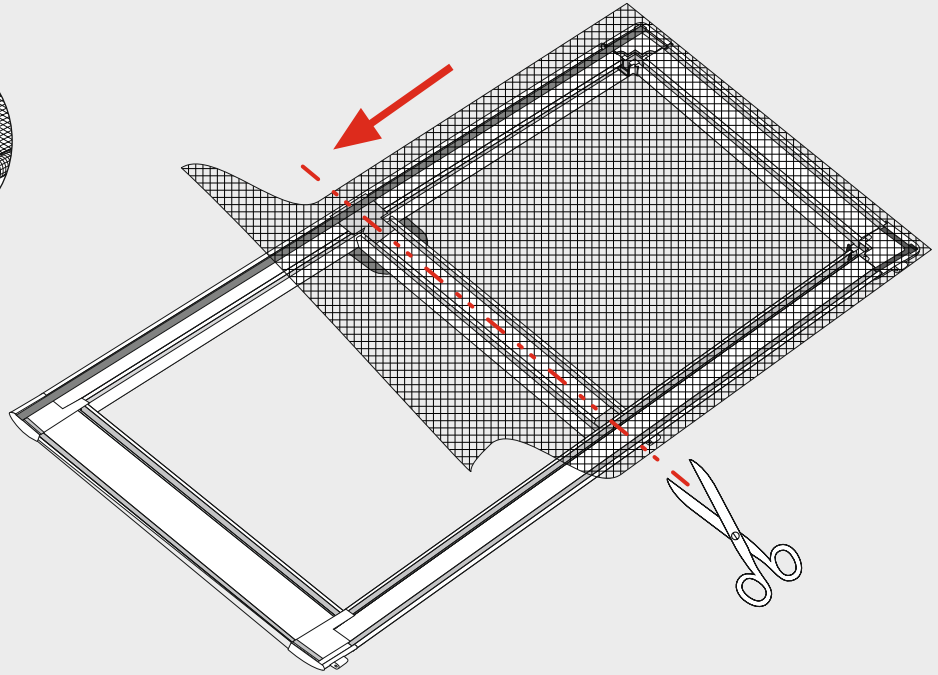
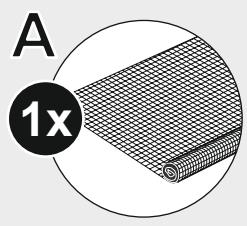
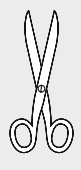

16

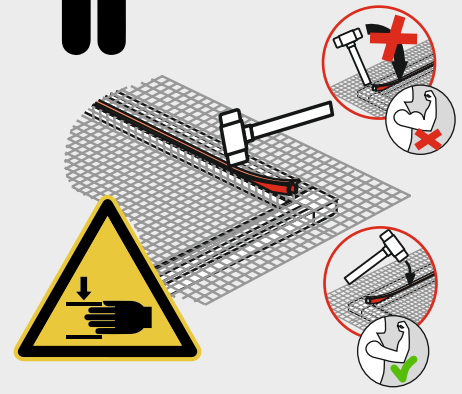
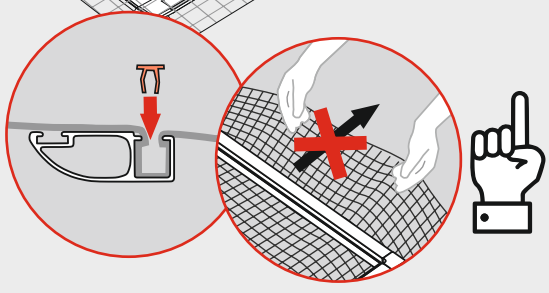
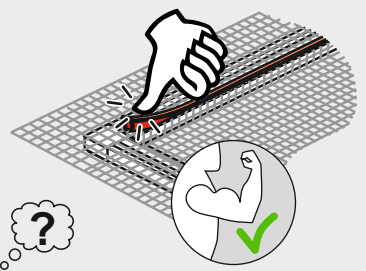
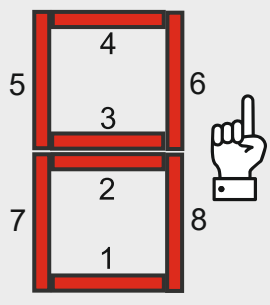
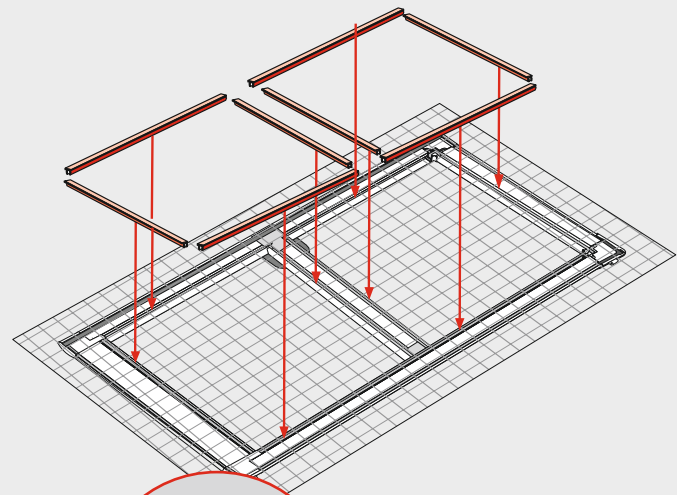
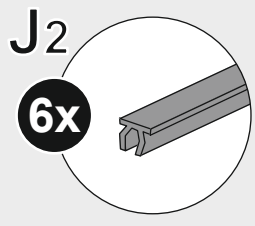
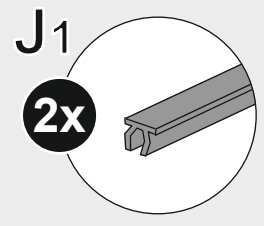

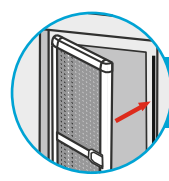

2 → 26

17

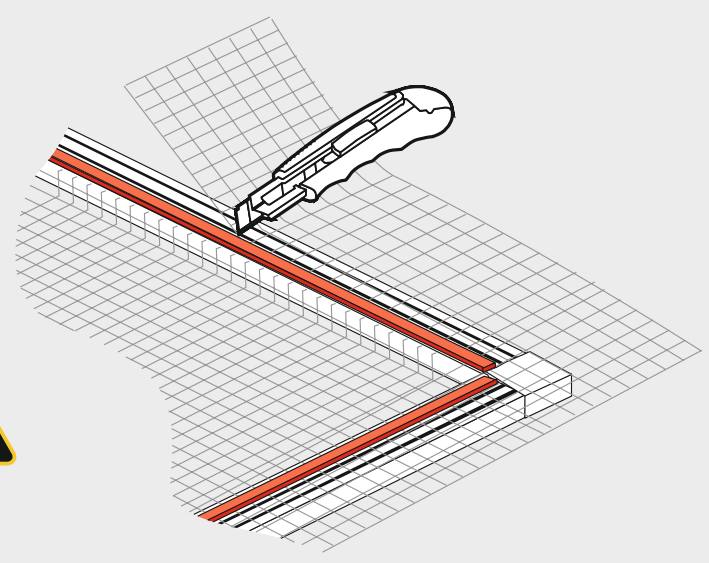

18

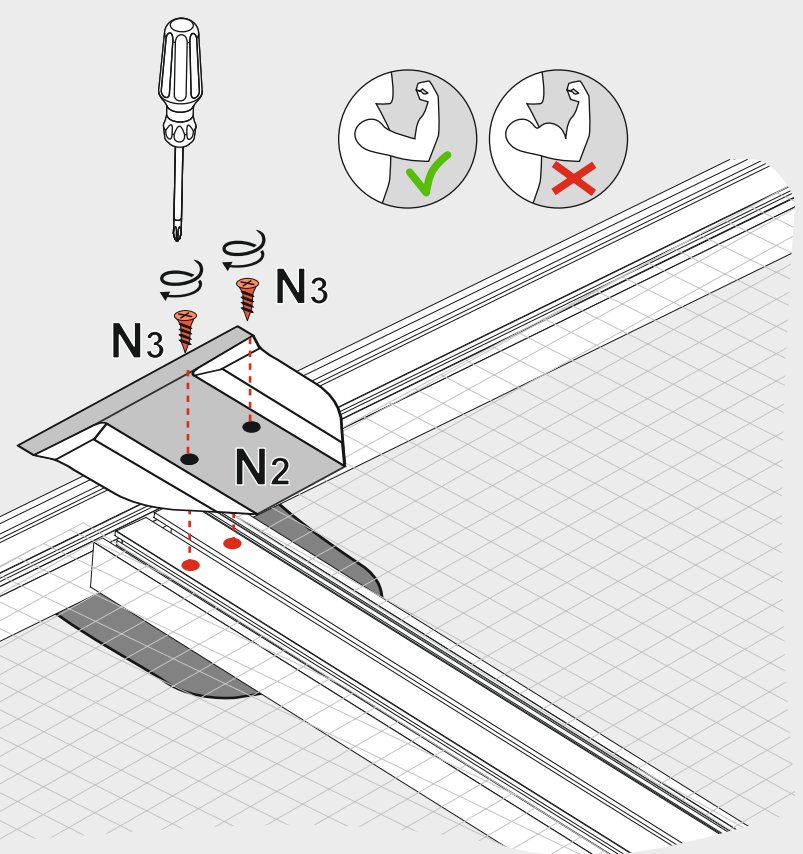
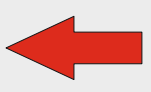
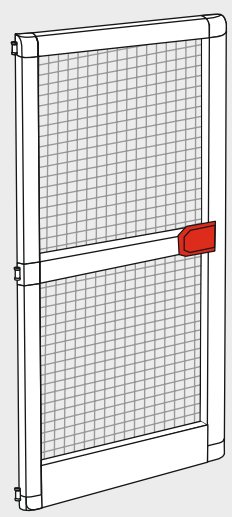
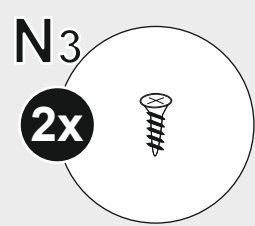
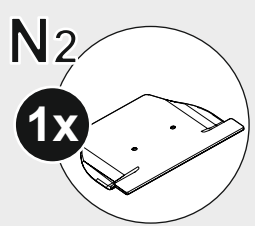
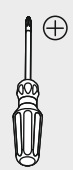

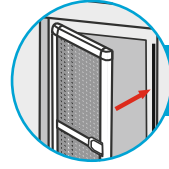

2 → 26

19

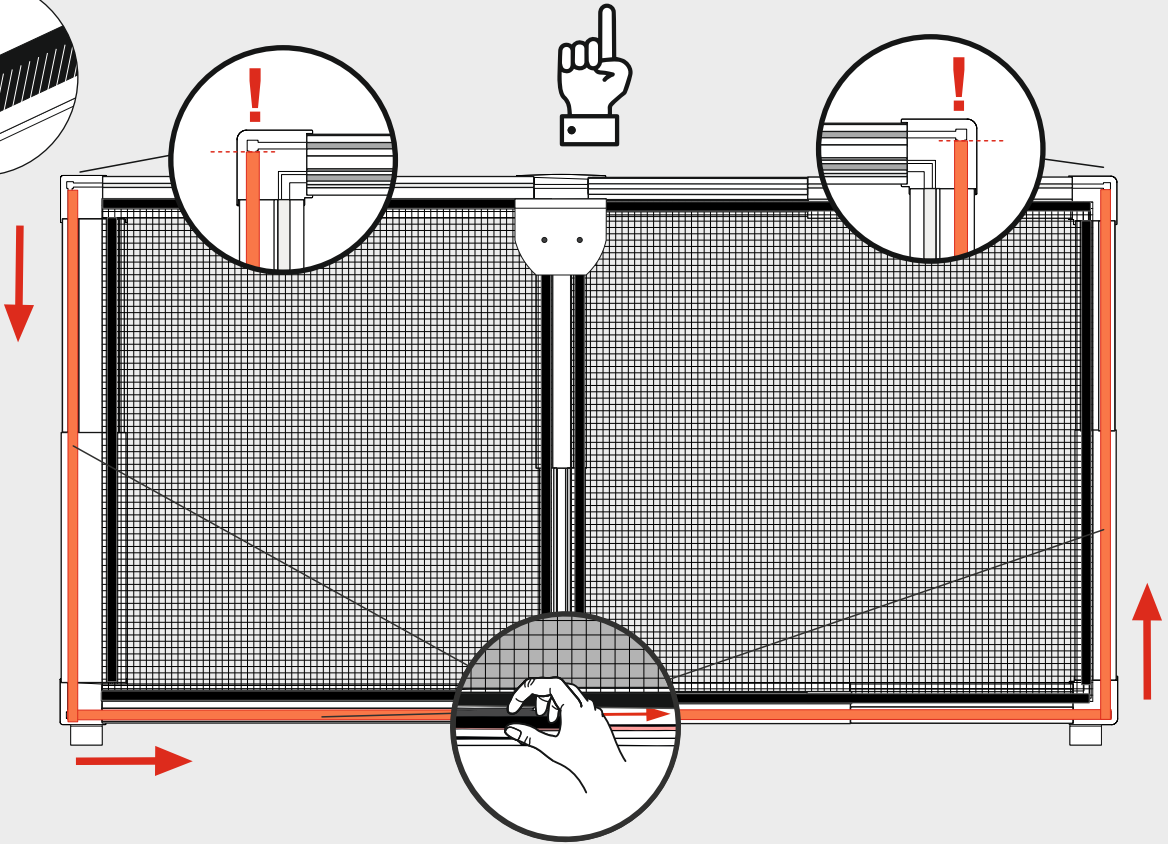
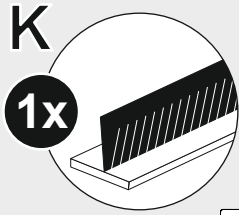
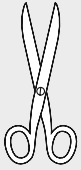

20

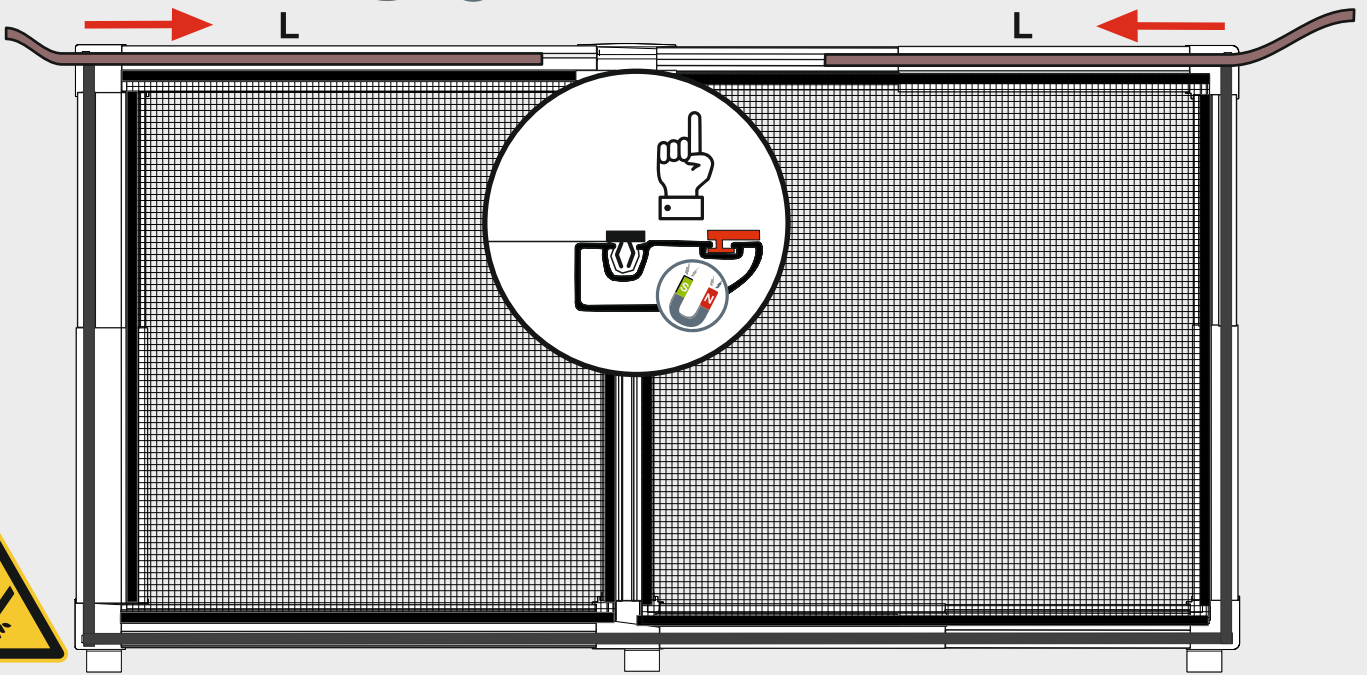
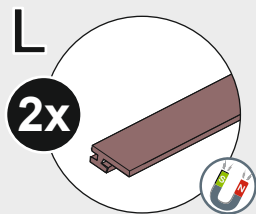
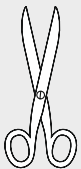

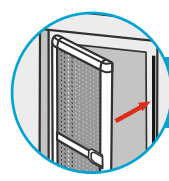

2 → 26

21

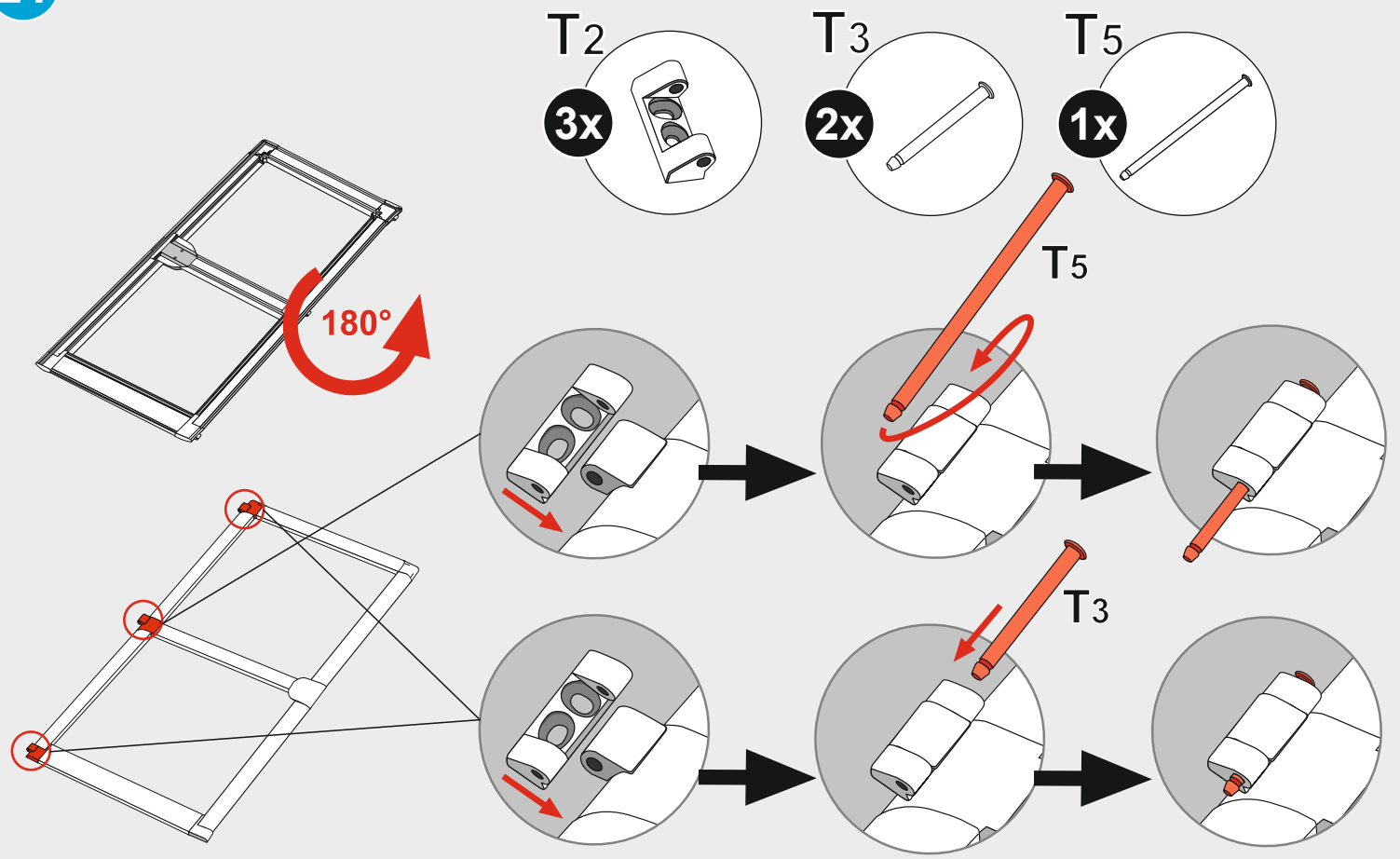

22

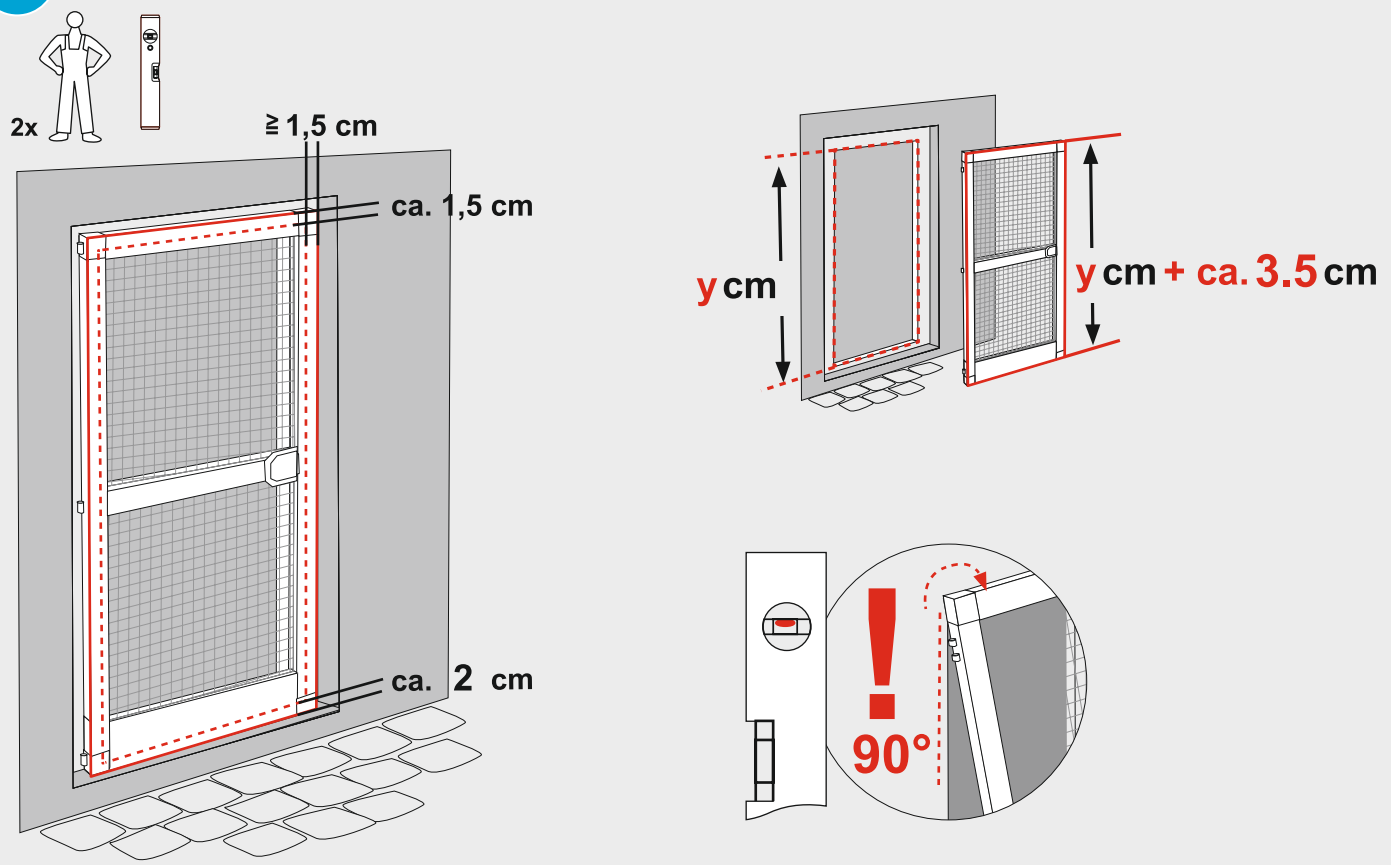

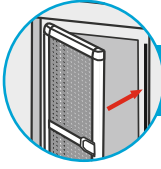

2 → 26

23

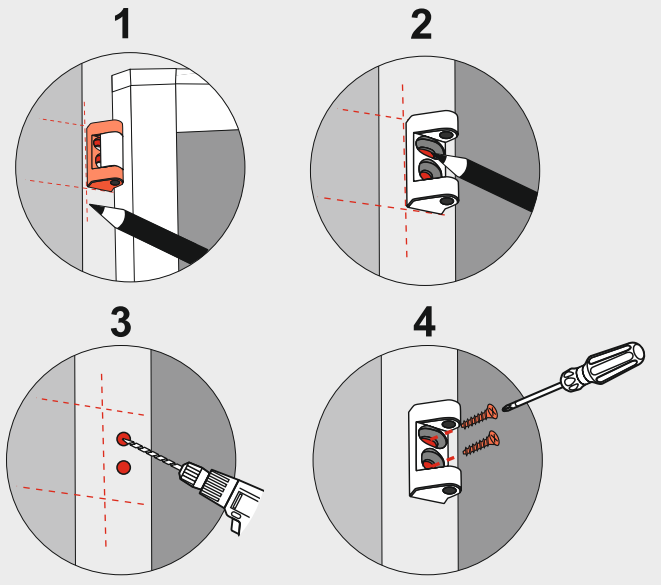
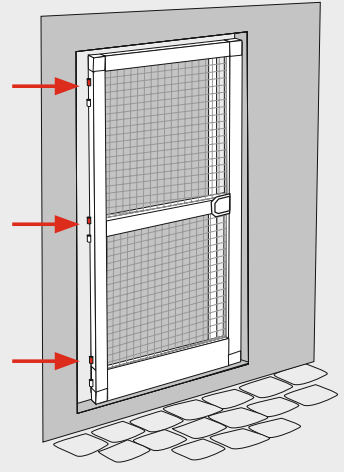
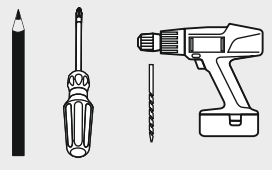

24

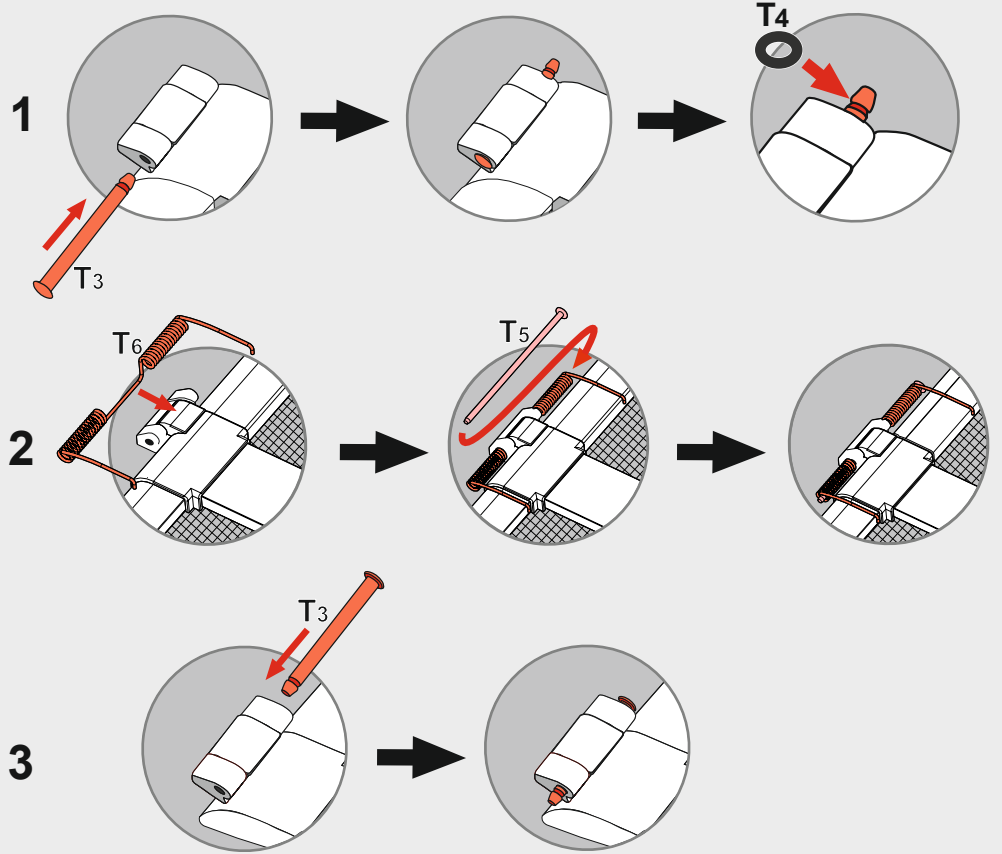
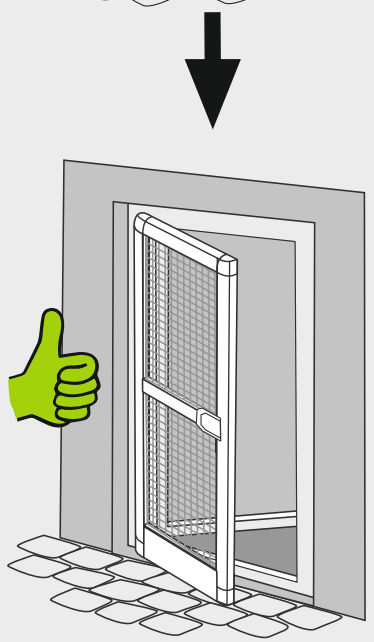
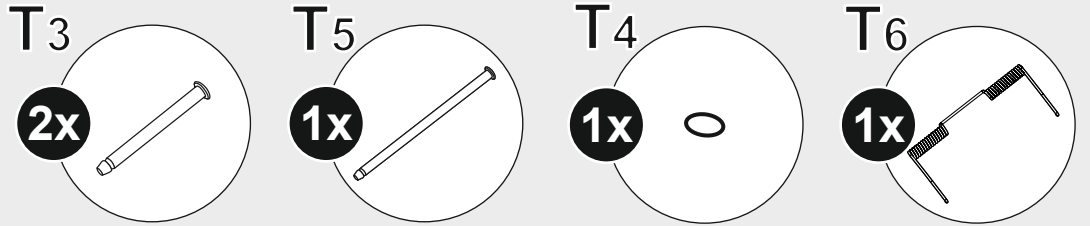
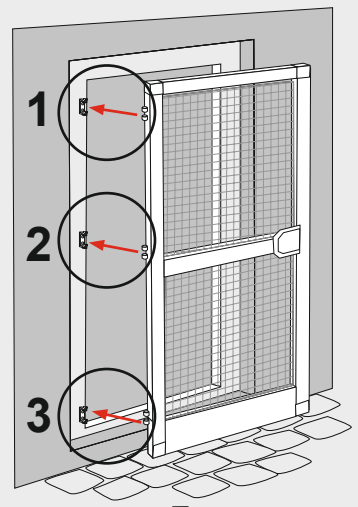

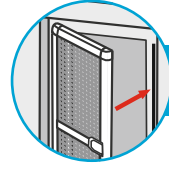

2 → 26

25

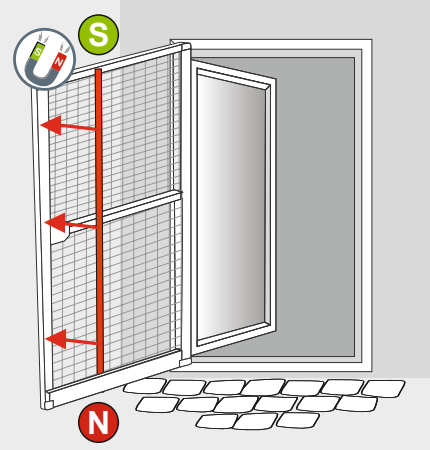
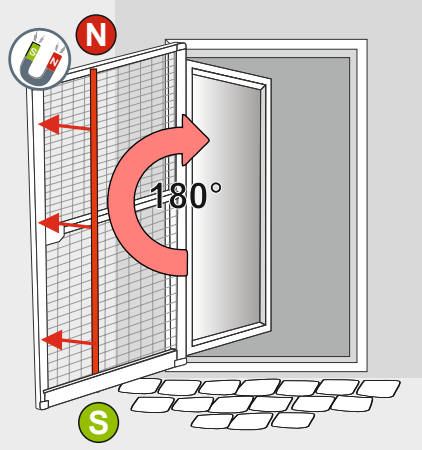
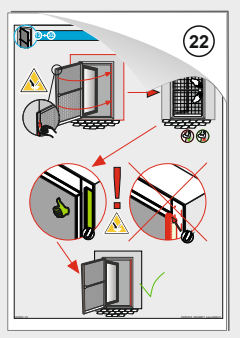
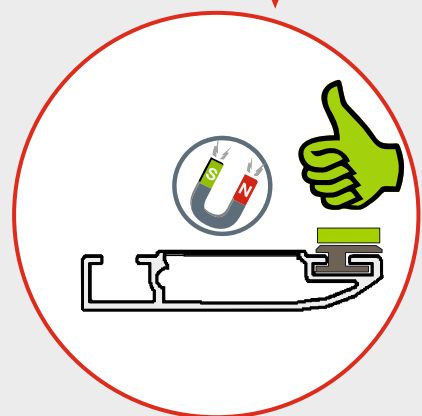
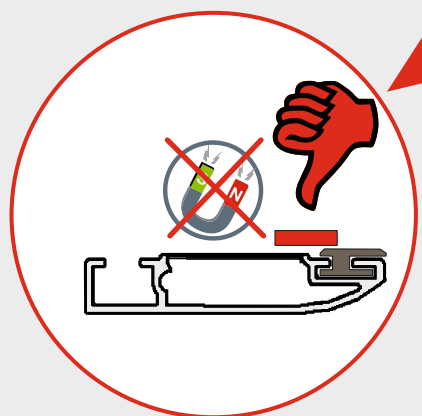
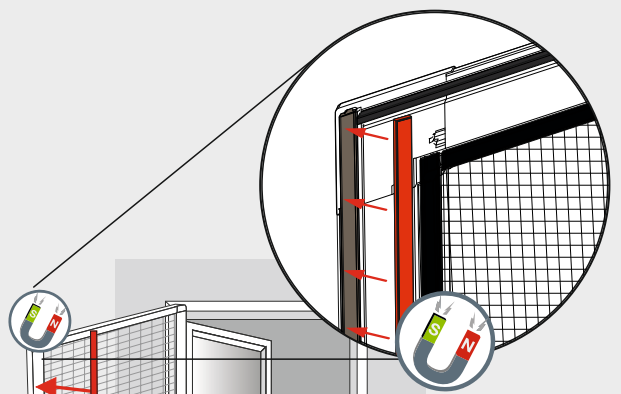
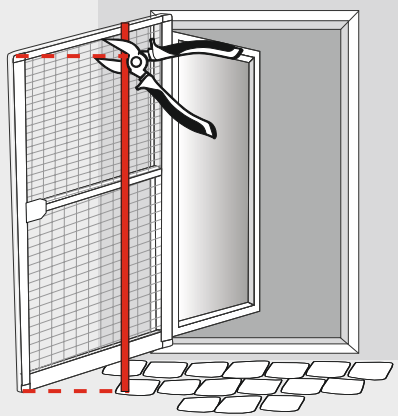
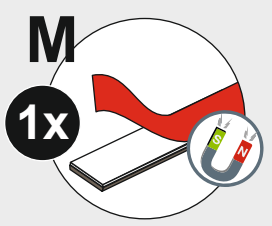

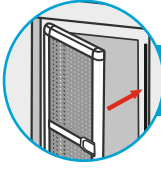

2 → 26

26

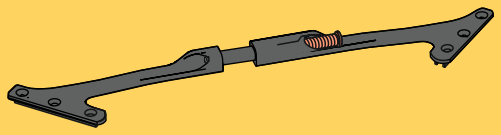
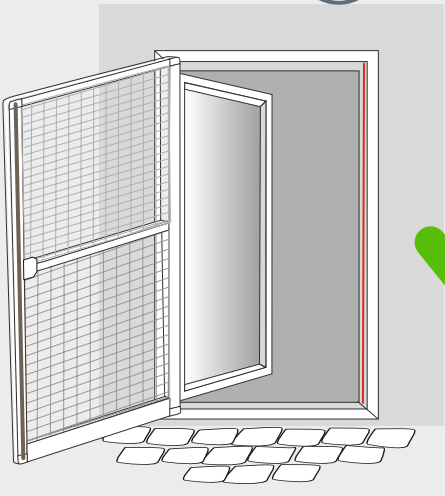
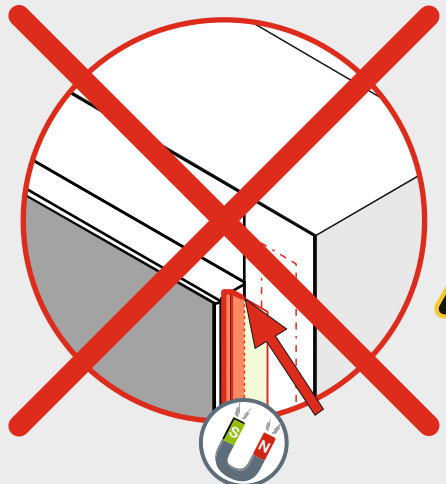
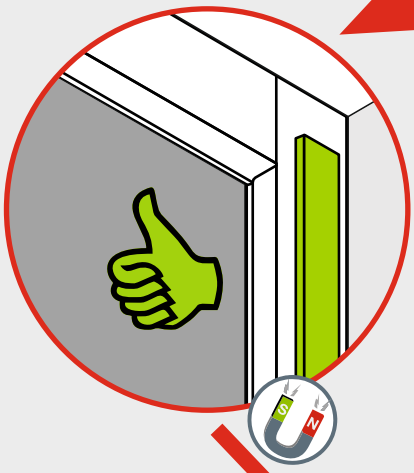
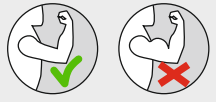
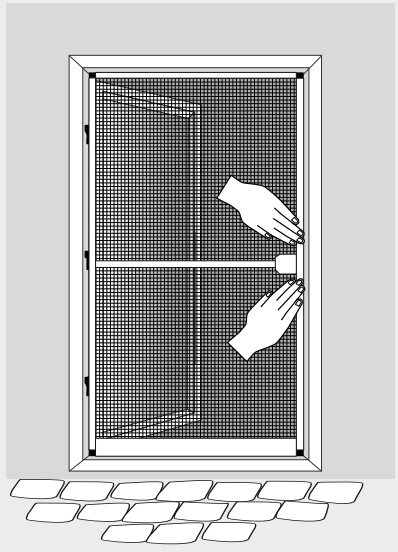
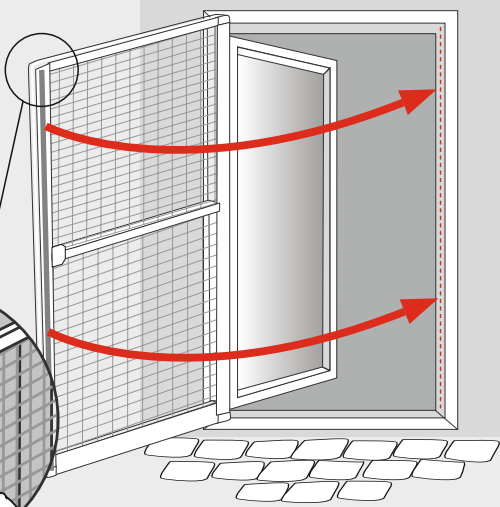
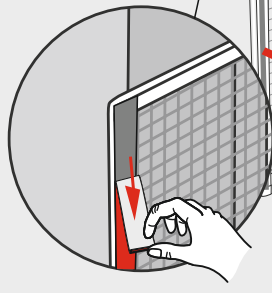

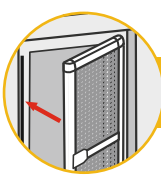

27 → 51

i

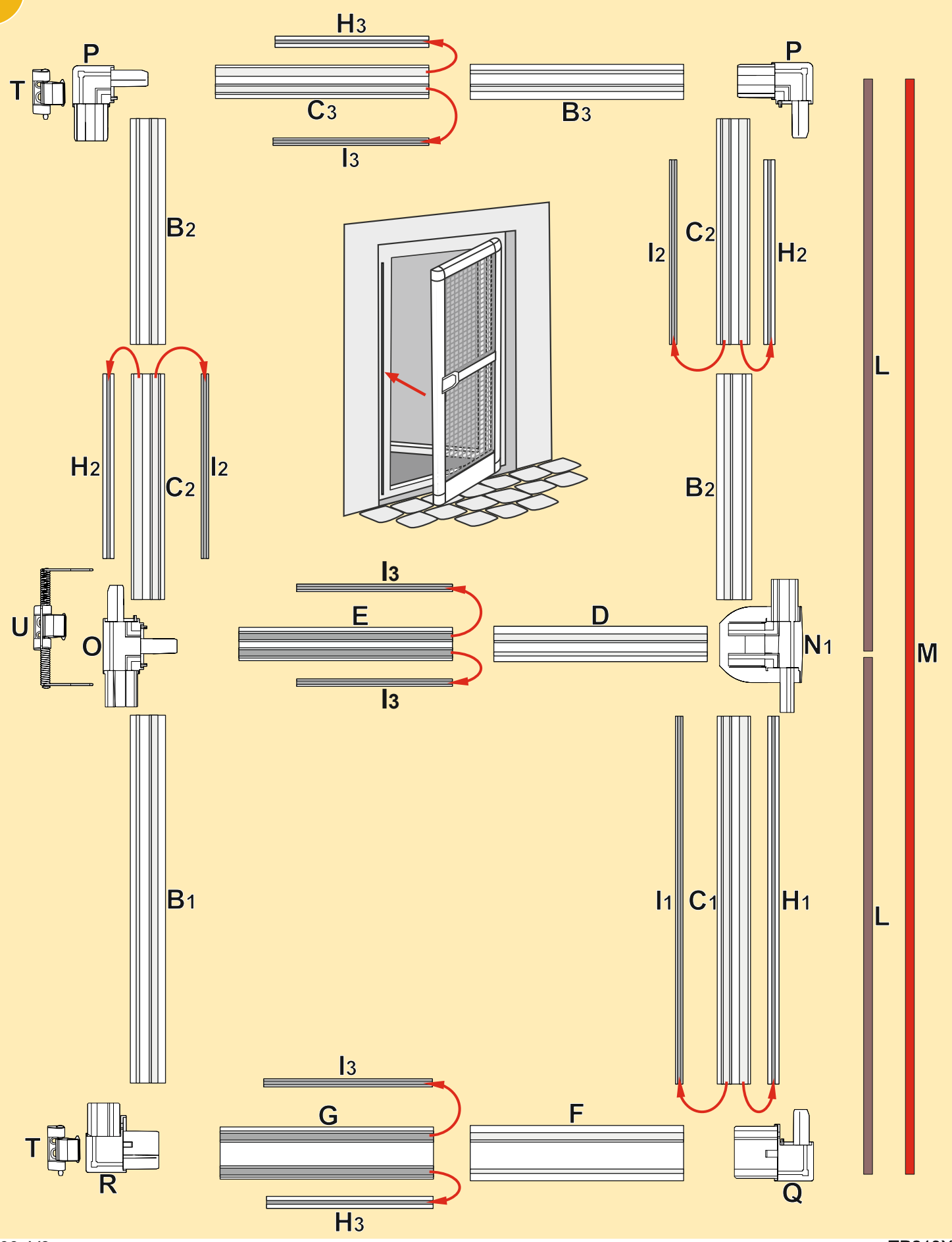

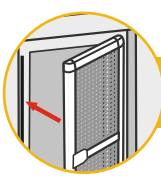

27 → 51

27

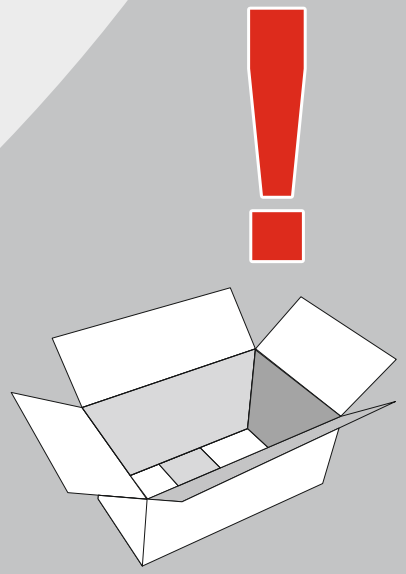
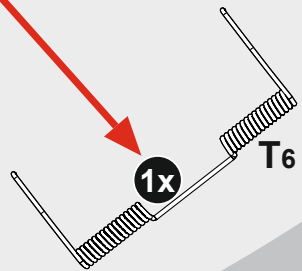
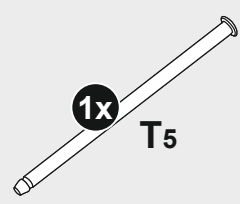
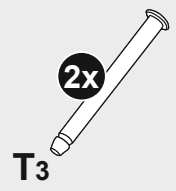
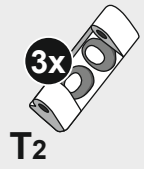
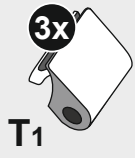
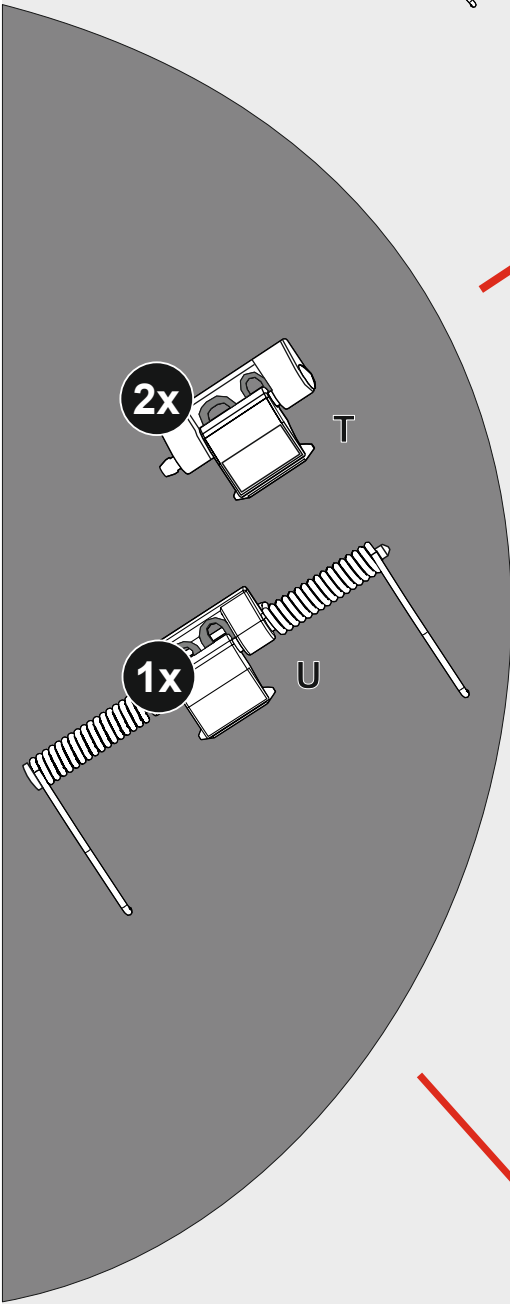
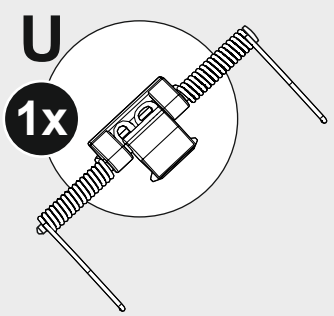
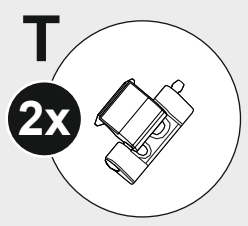

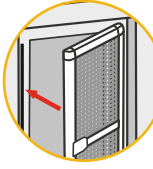

27 → 51

28

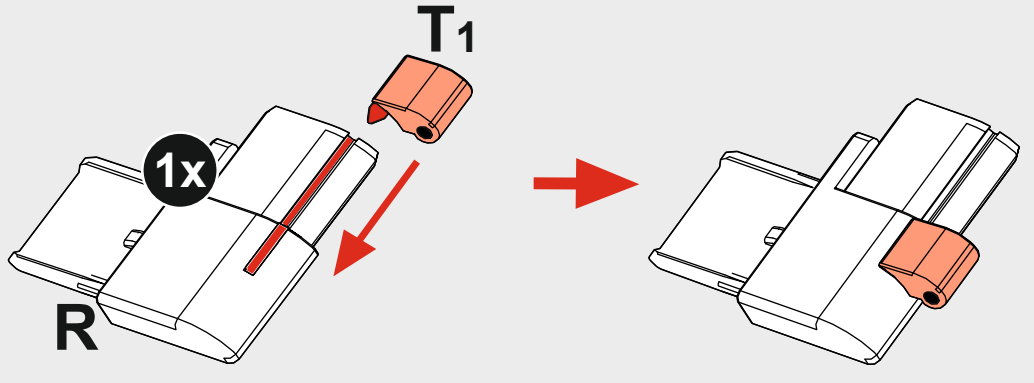
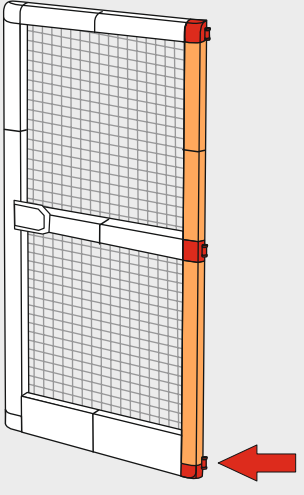
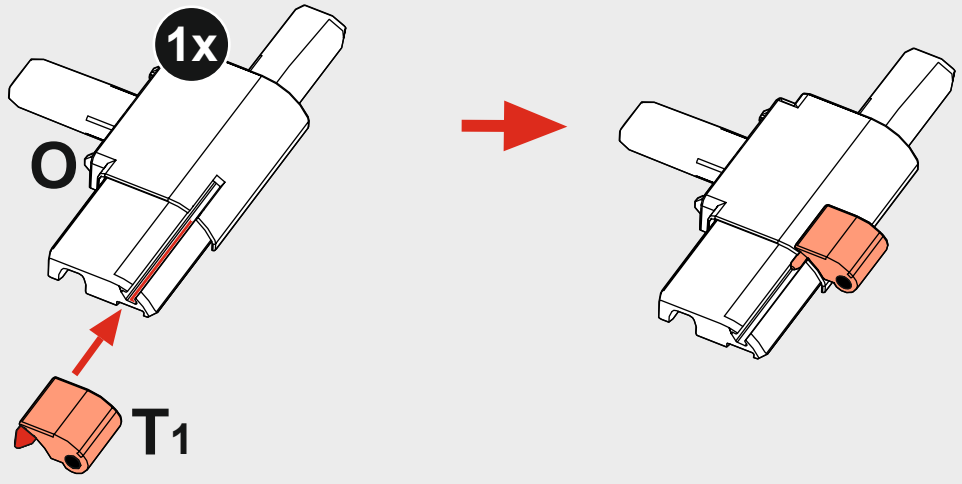
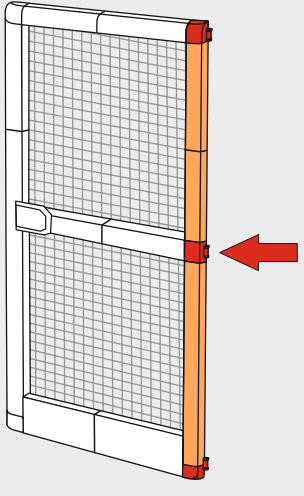
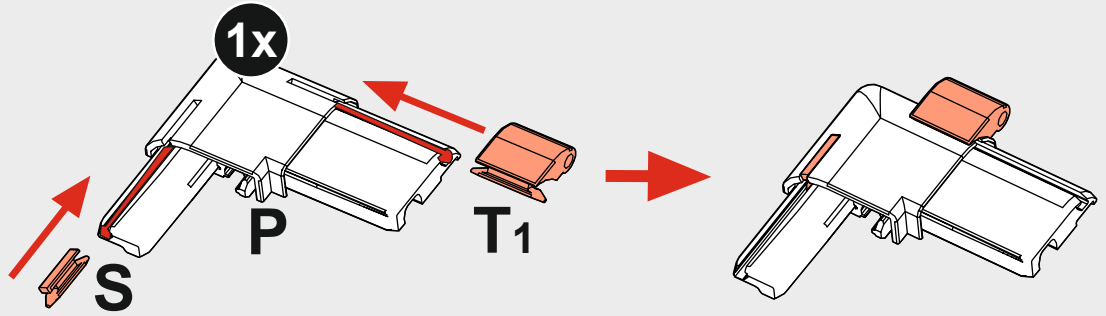
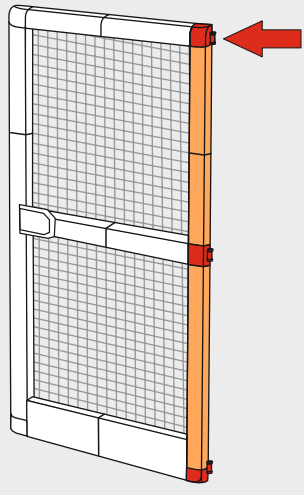
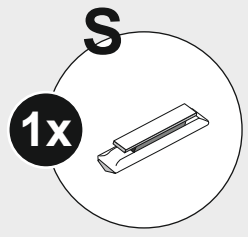
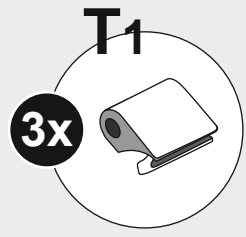
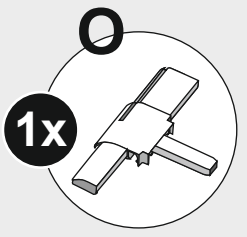
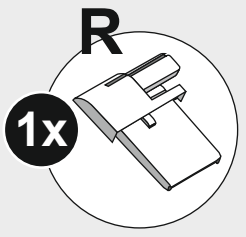
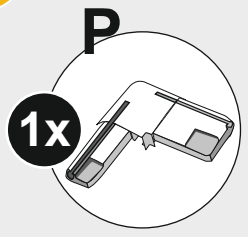

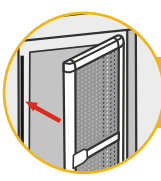

27 → 51

29

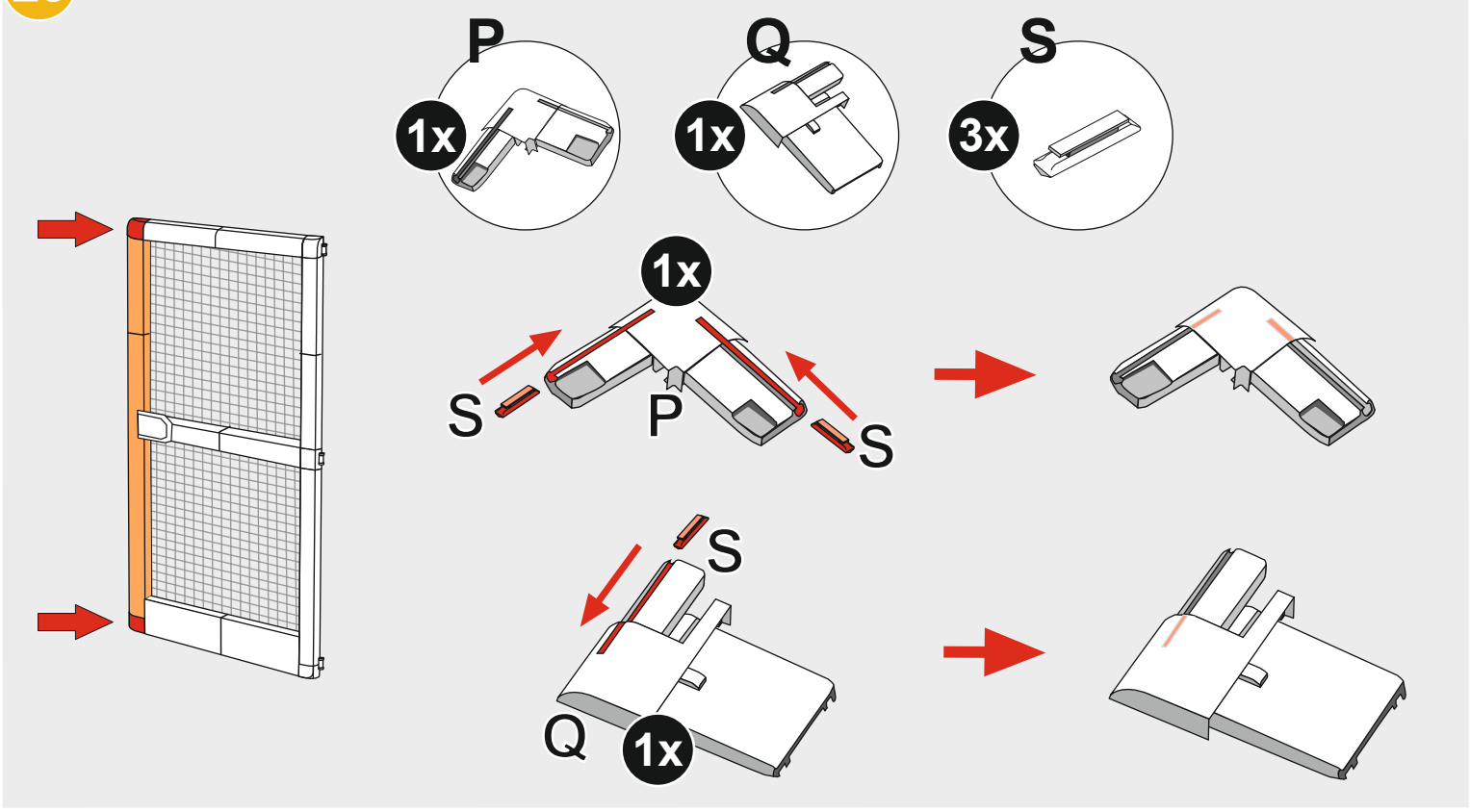

30

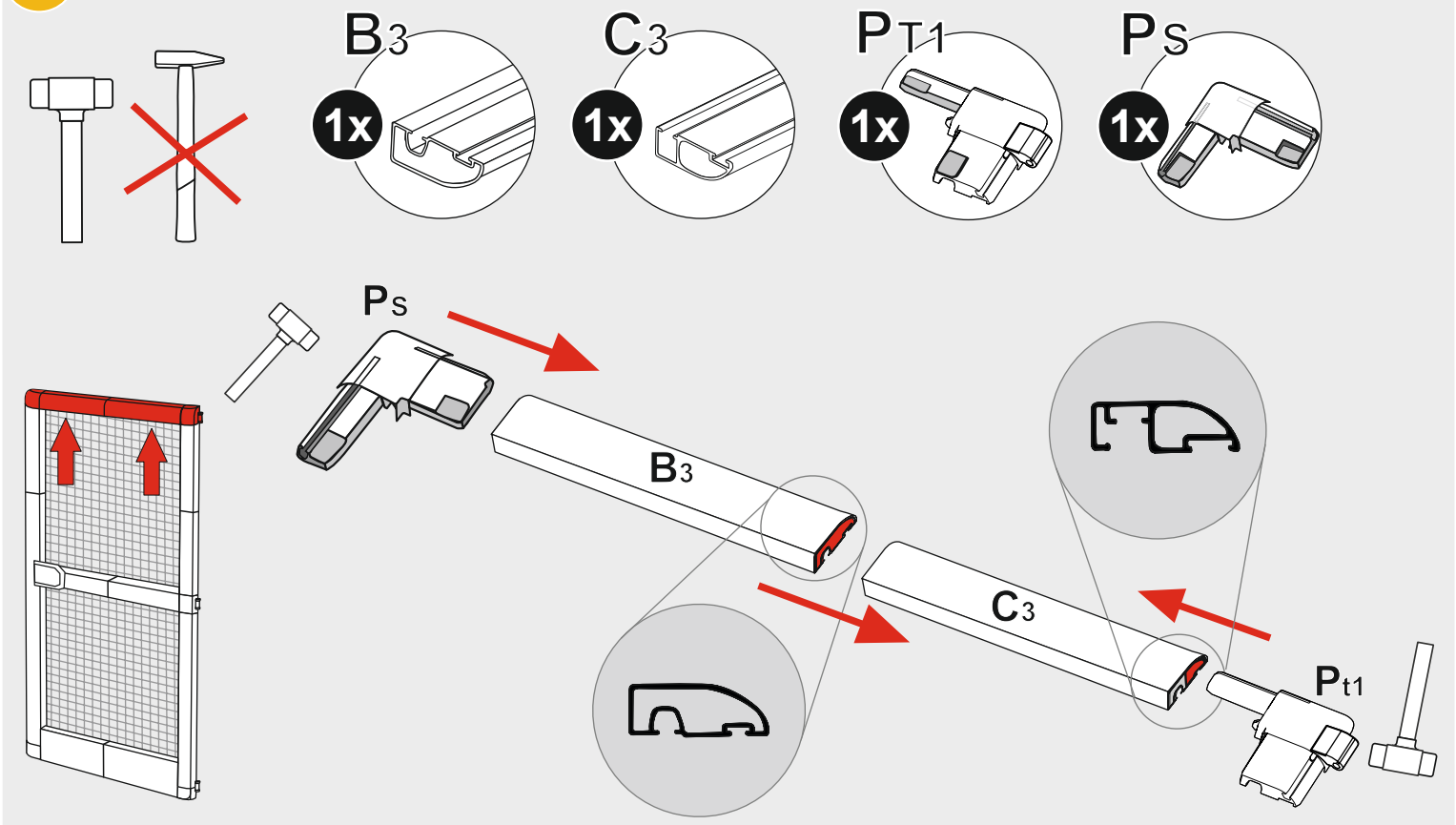

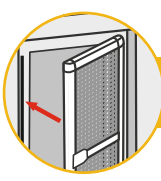

27 → 51

31

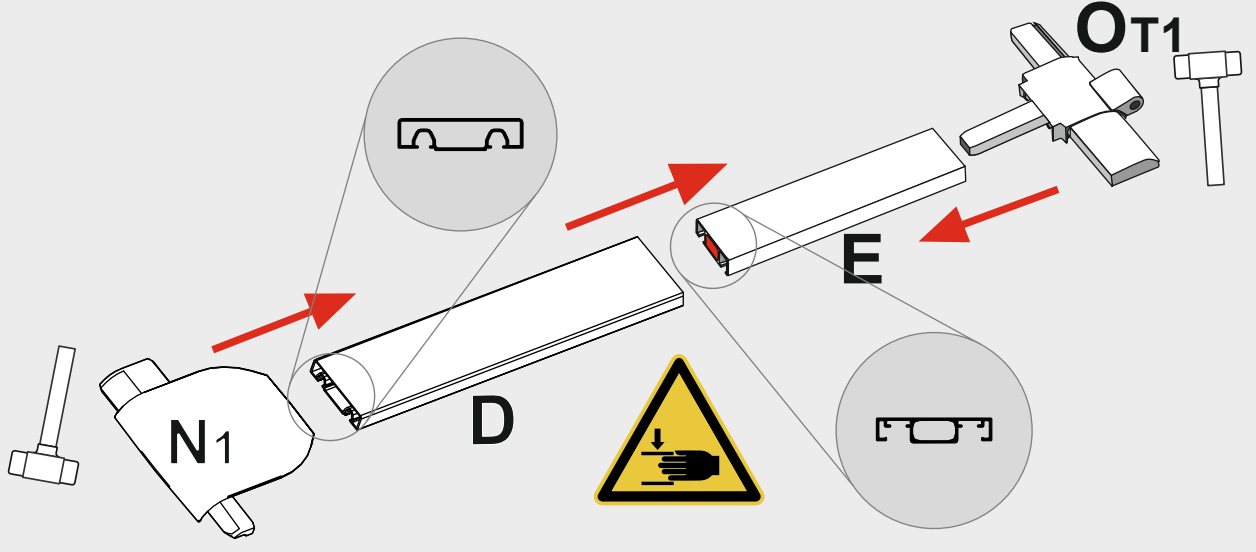
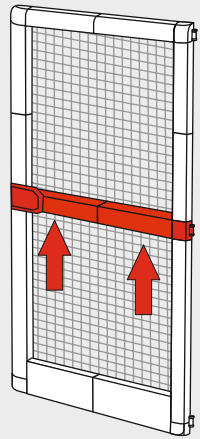
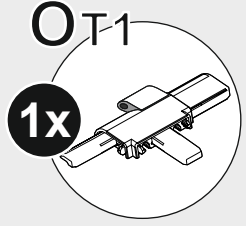
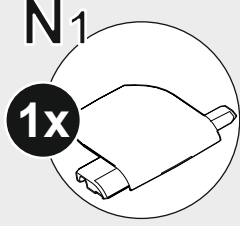
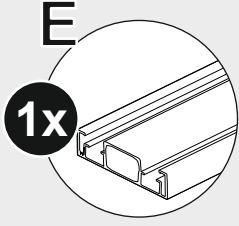
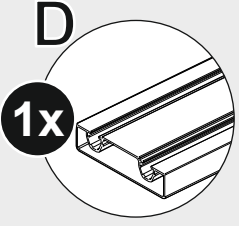
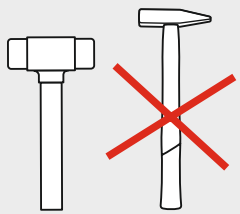

32

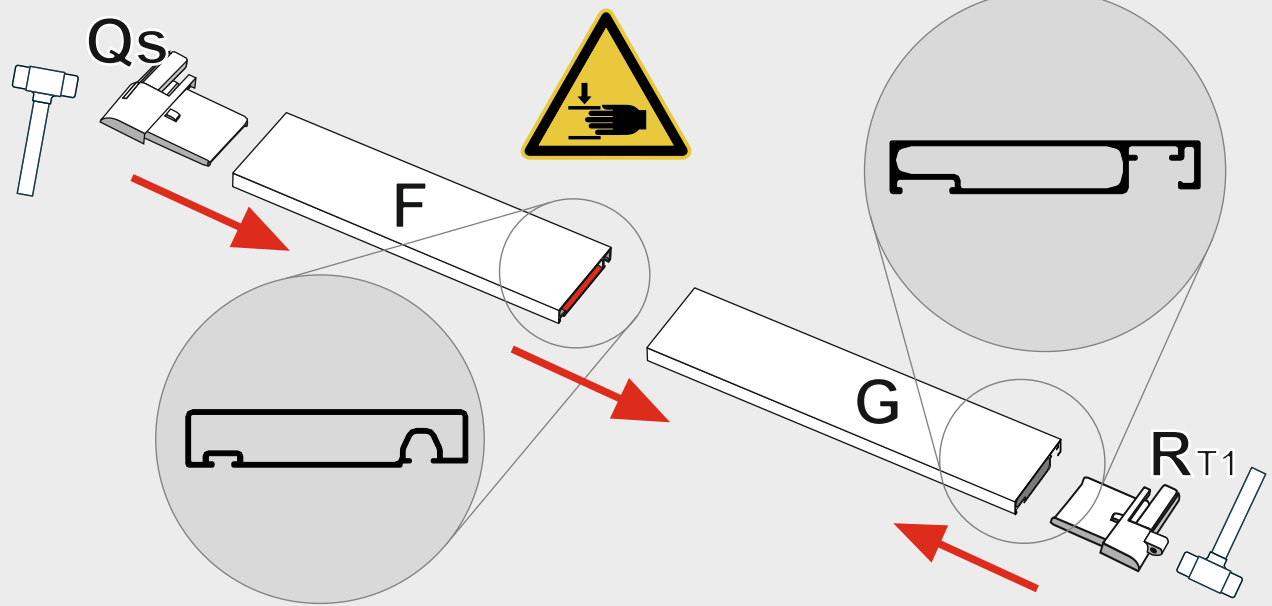
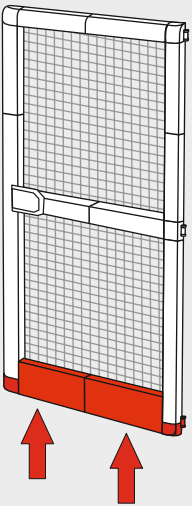
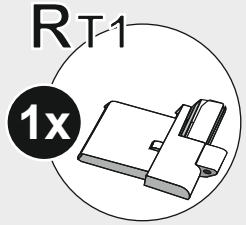
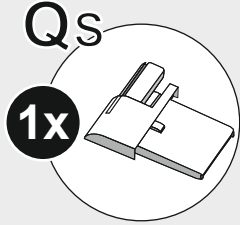
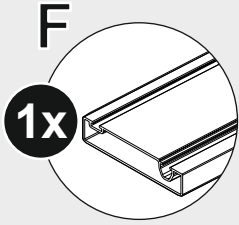
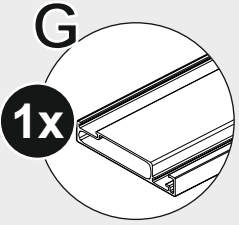
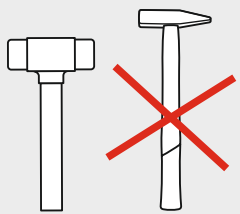

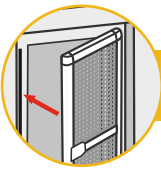

27 → 51

33

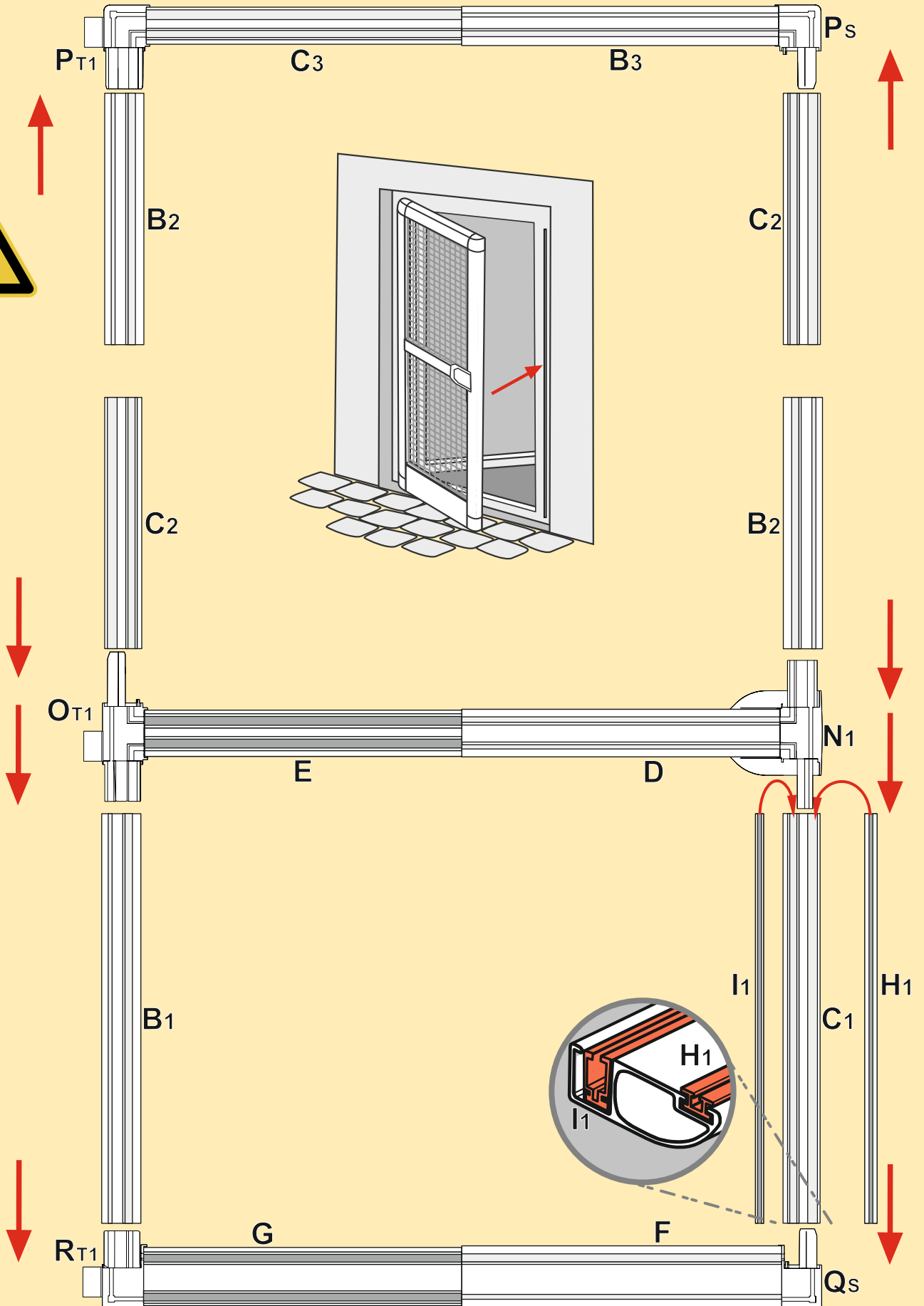

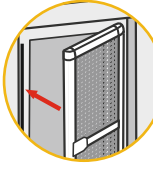

27 → 51

34

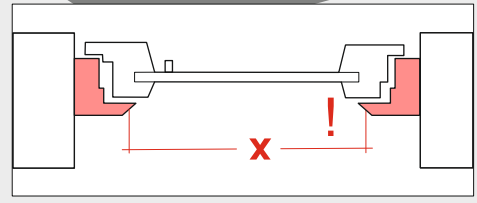
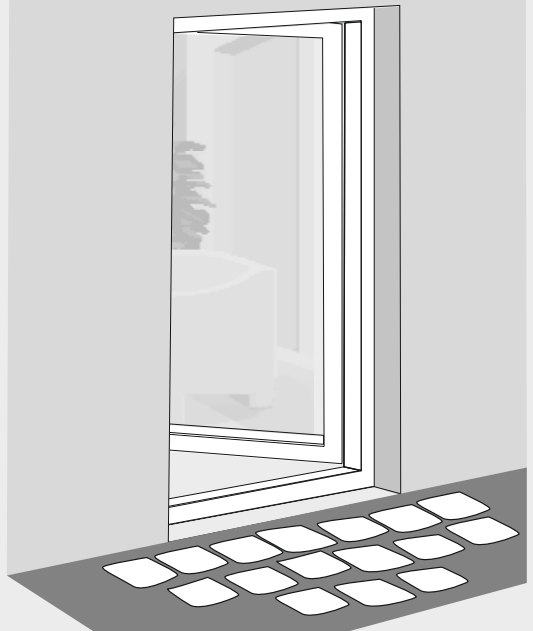
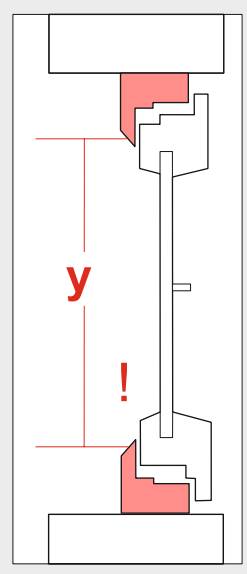
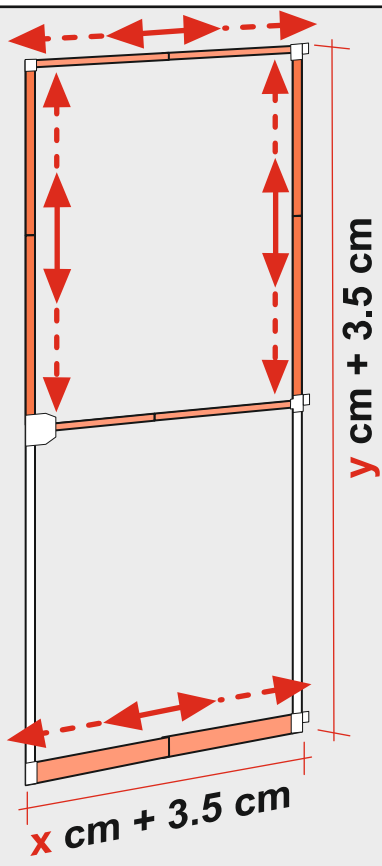

35

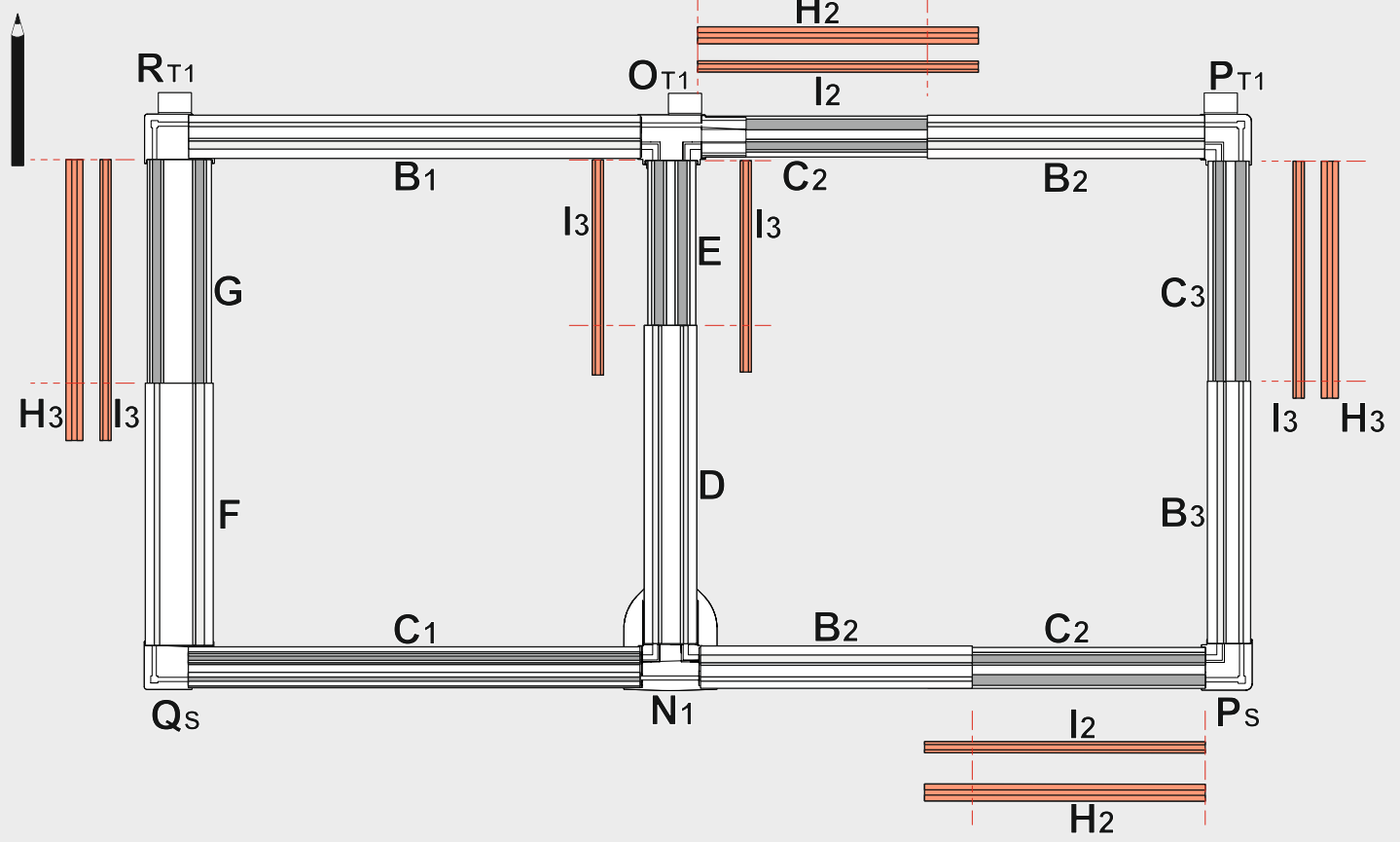

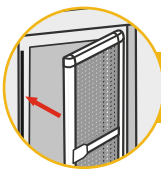

27 → 51

36

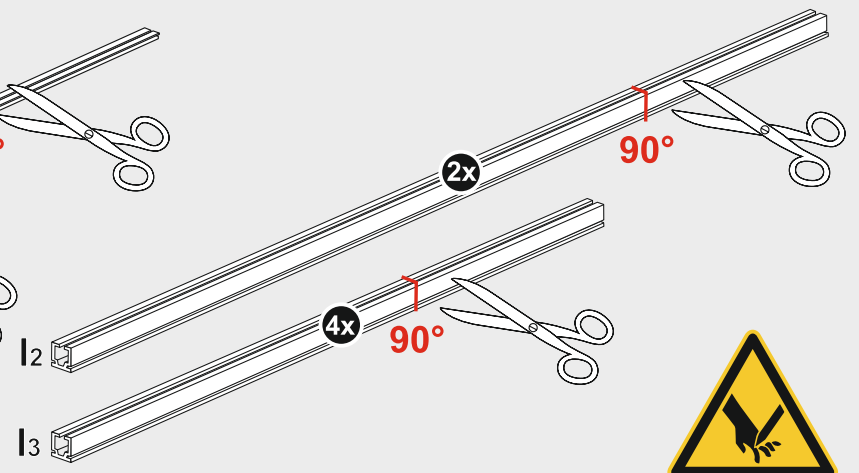
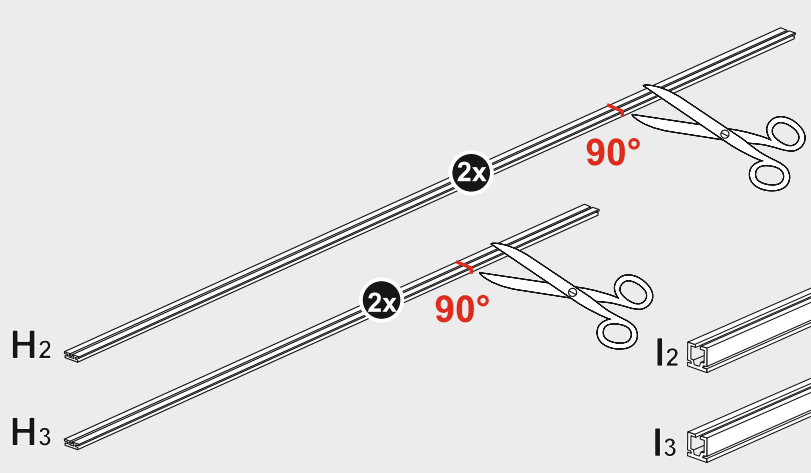
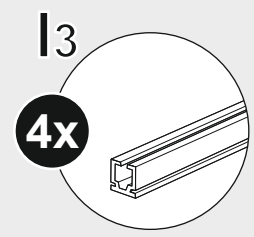
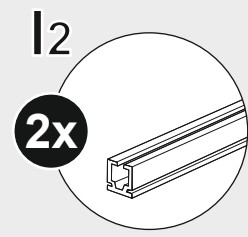
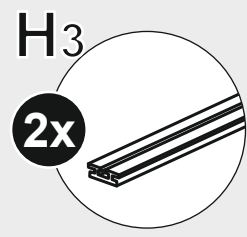
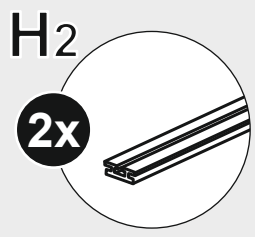
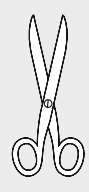

37

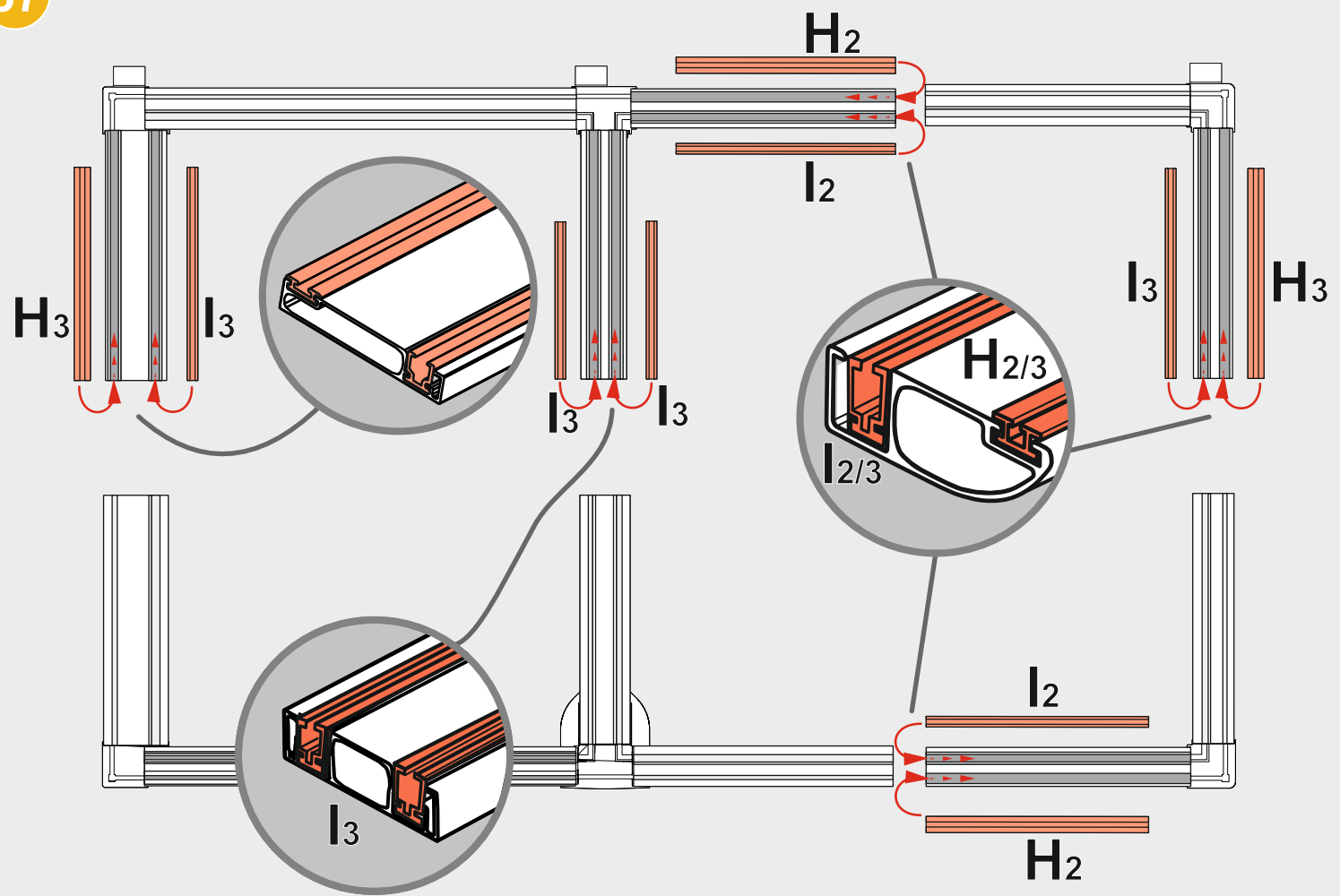

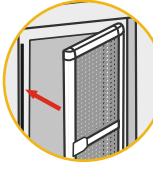

27 → 51

38

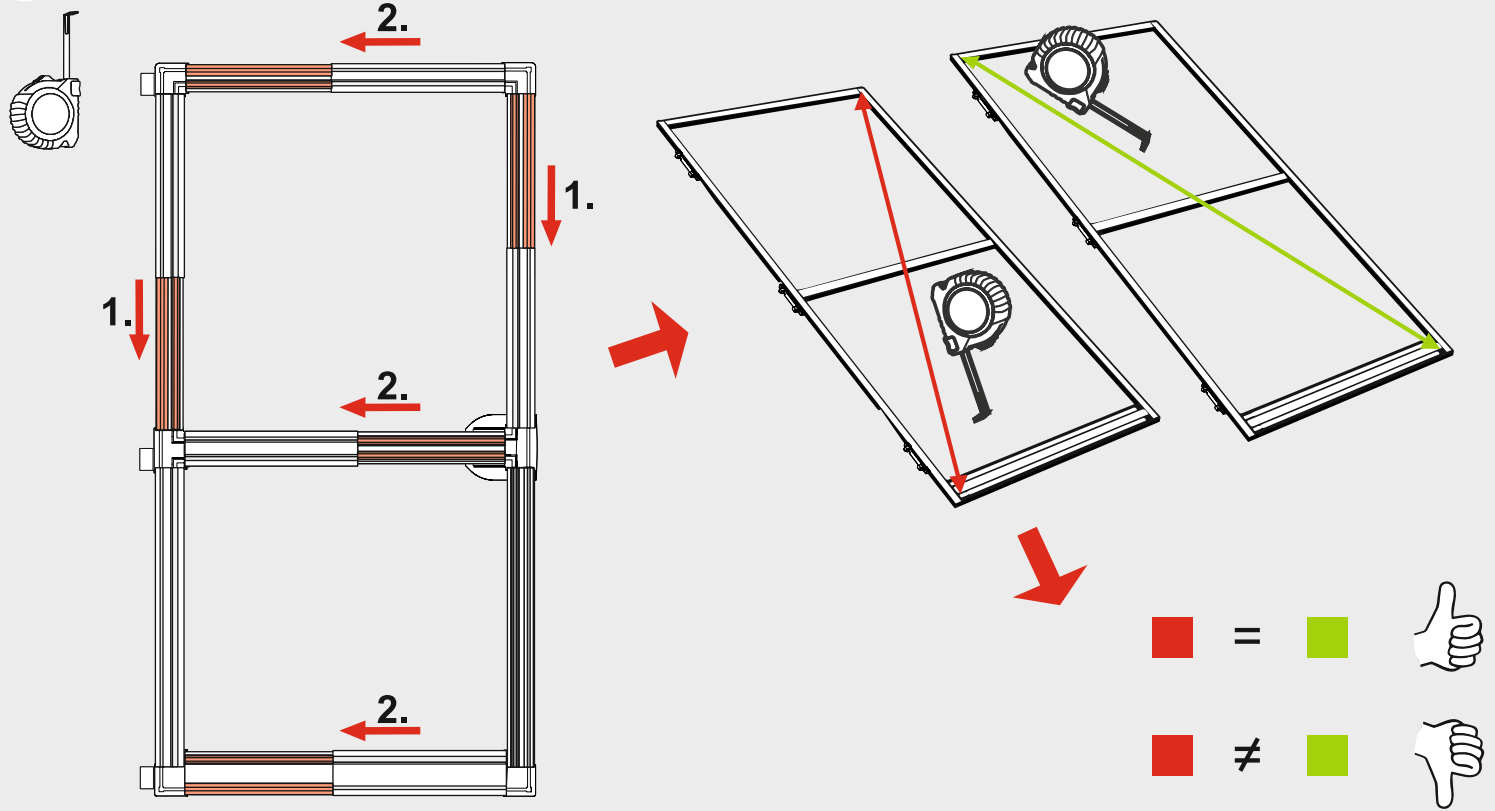

39

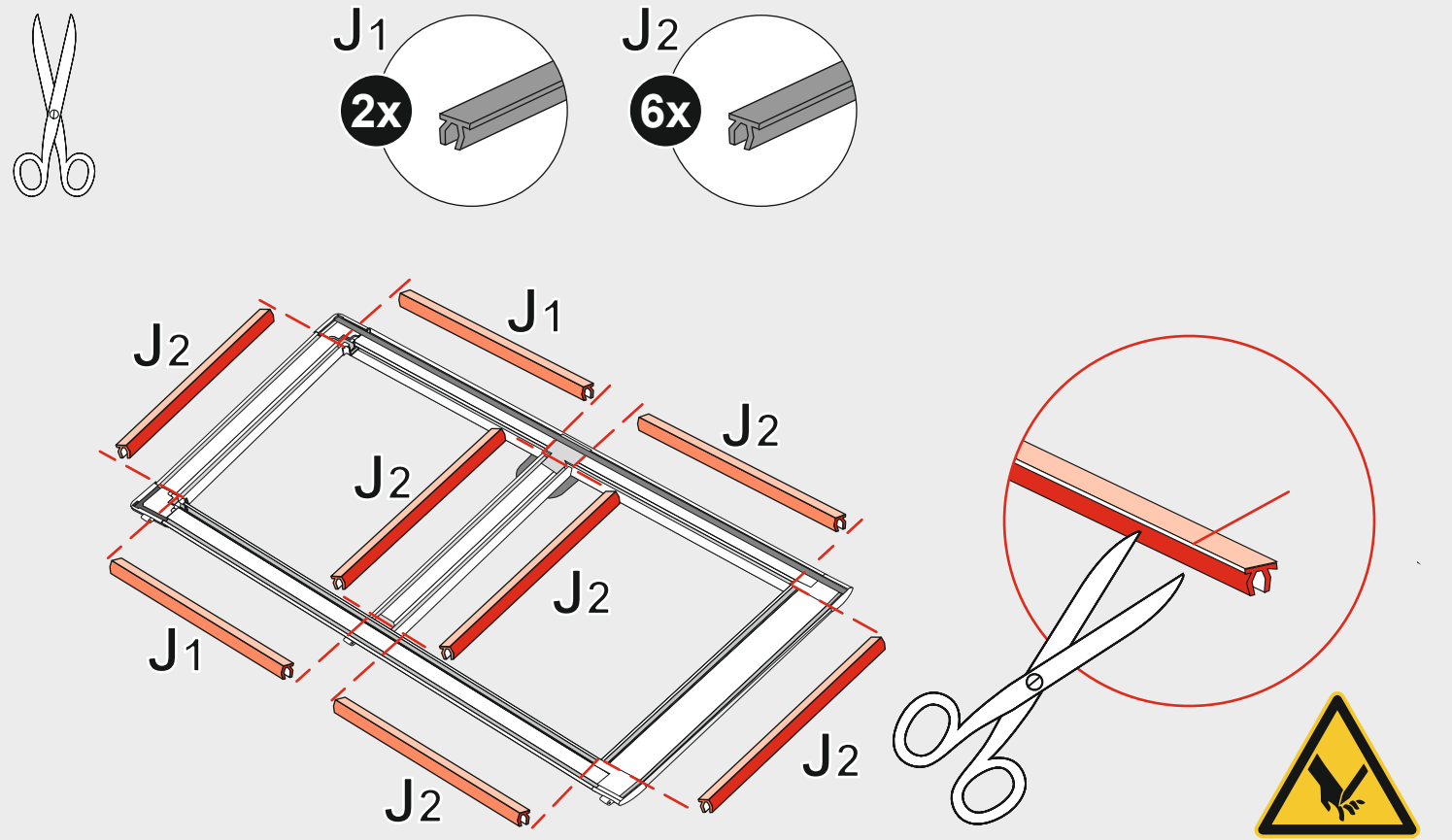

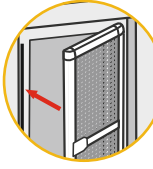

27 → 51

40

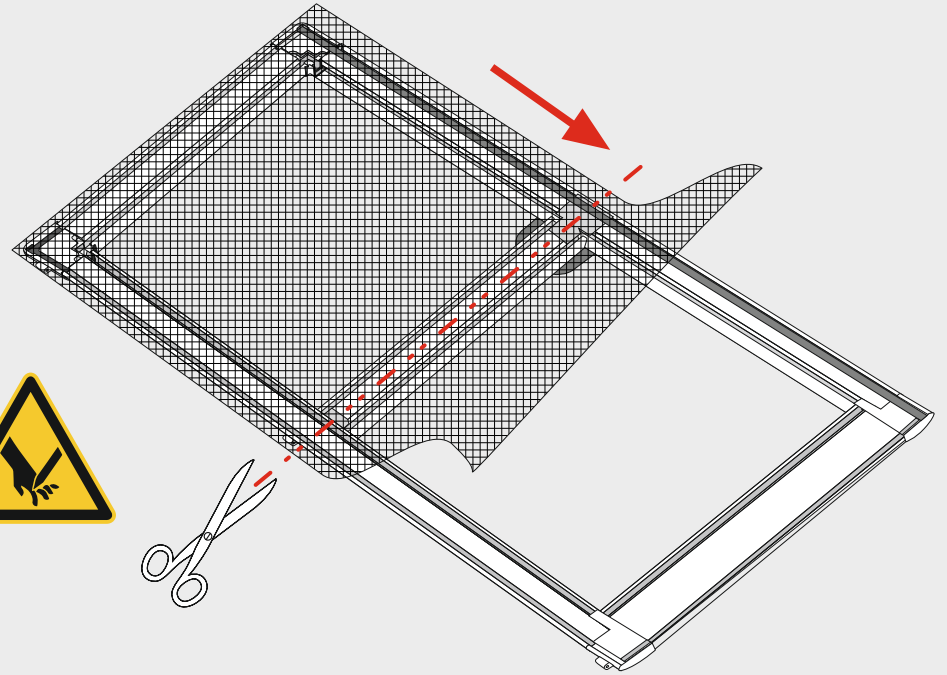
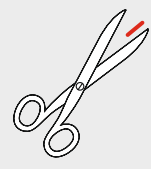
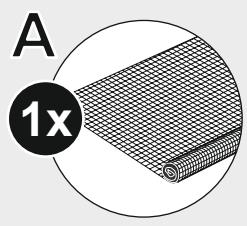
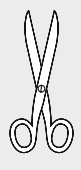

41

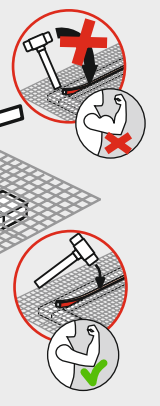
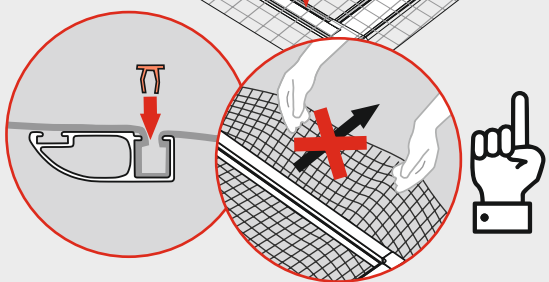
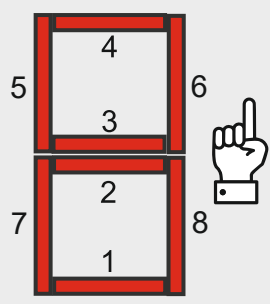
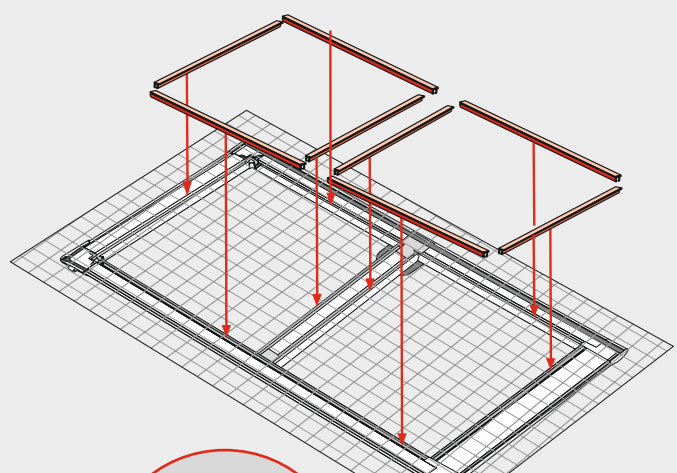
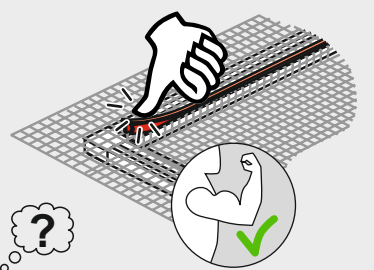
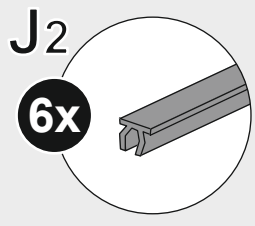
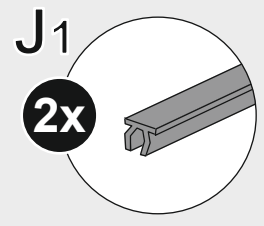

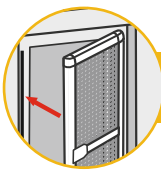

27 → 51

42

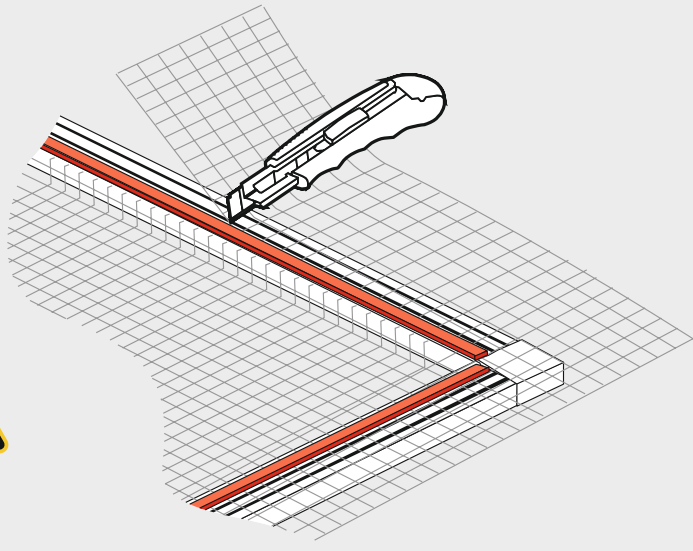

43

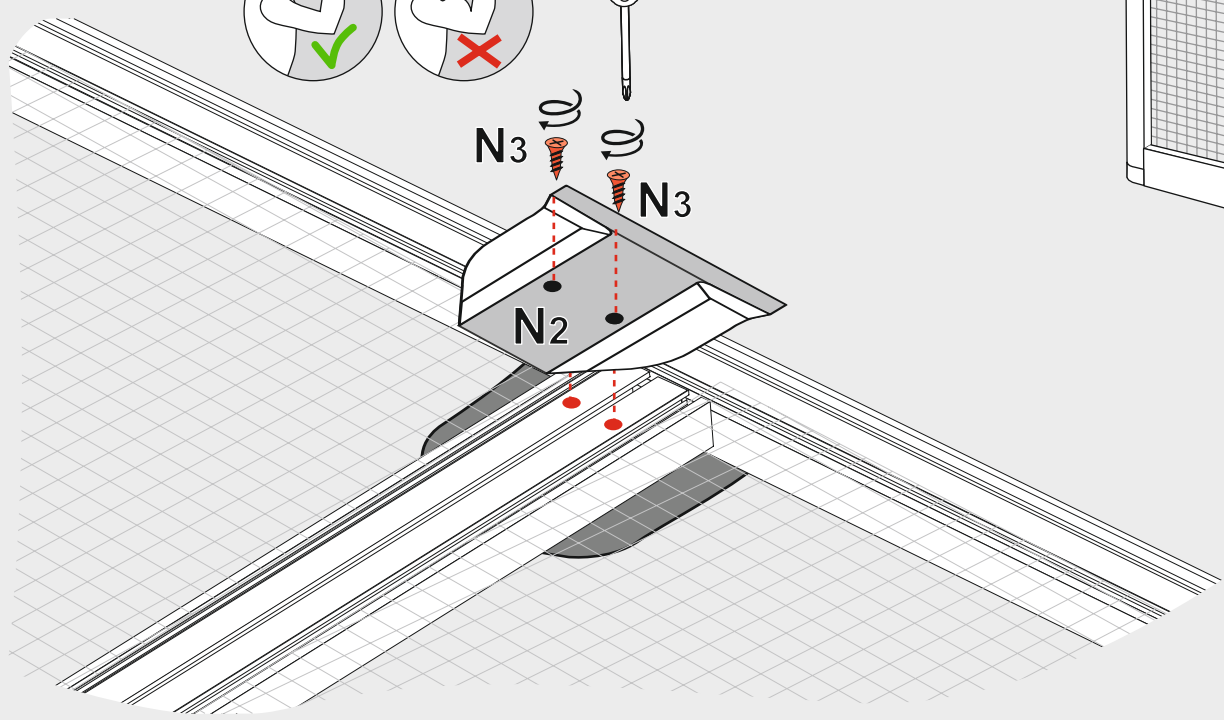
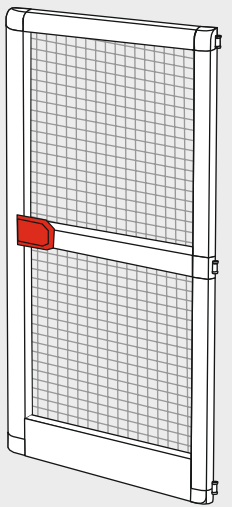
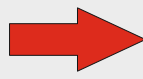
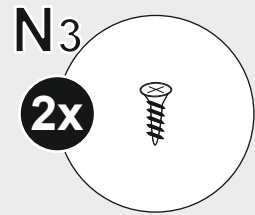
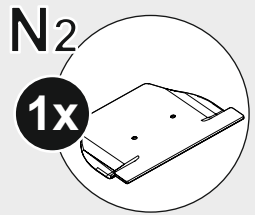

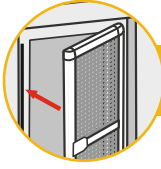

27 → 51

44

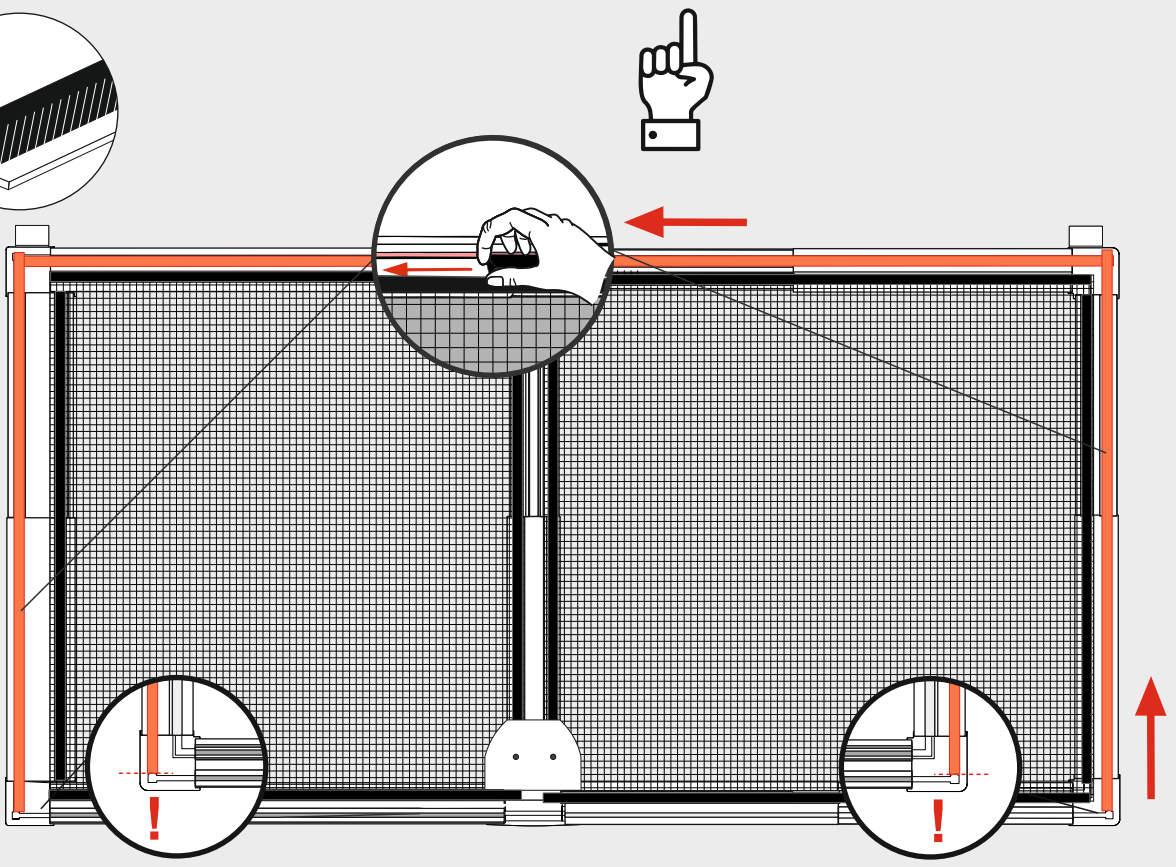
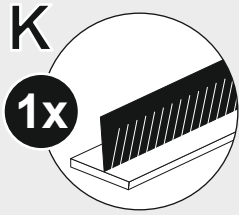
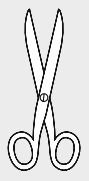

45

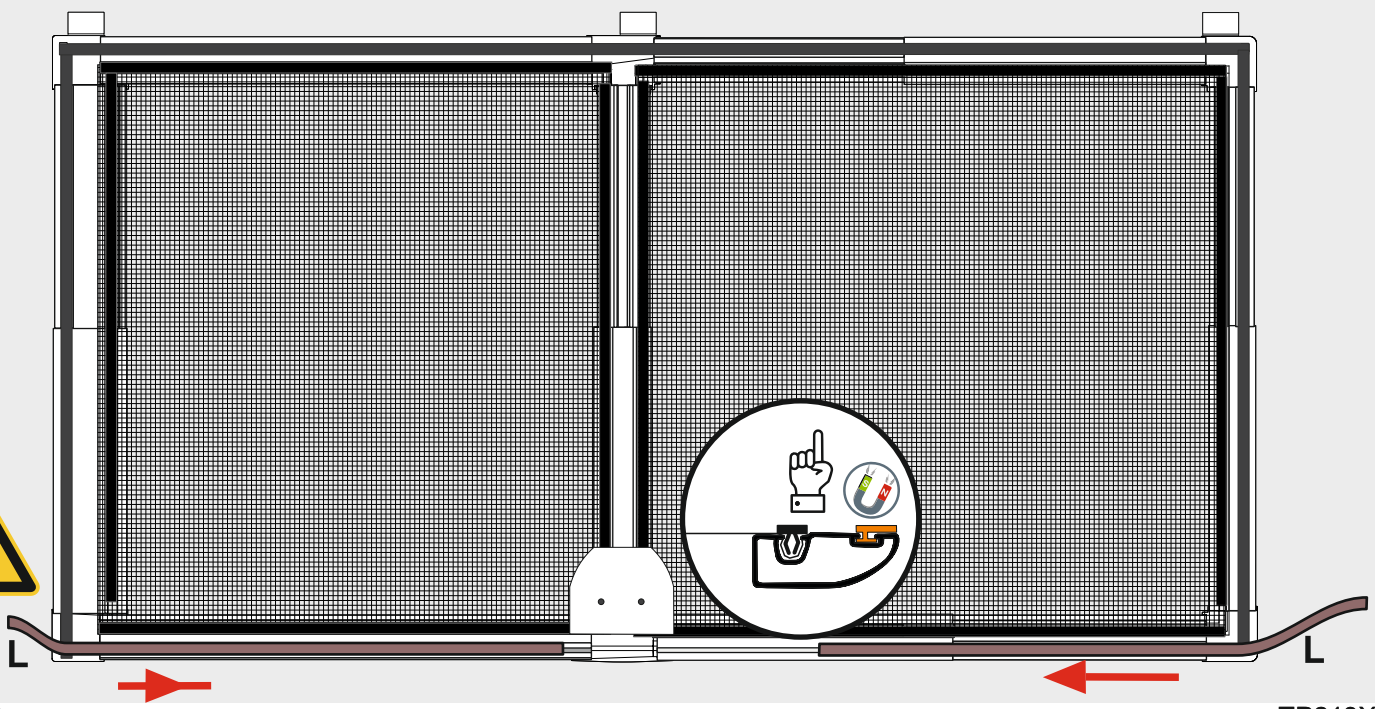
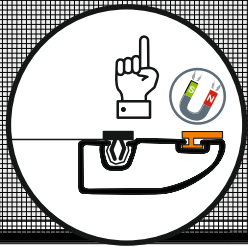
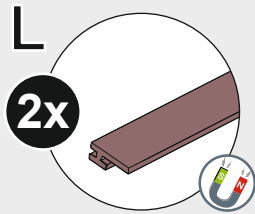
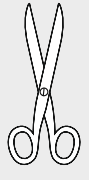

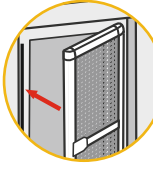

27 → 51

46

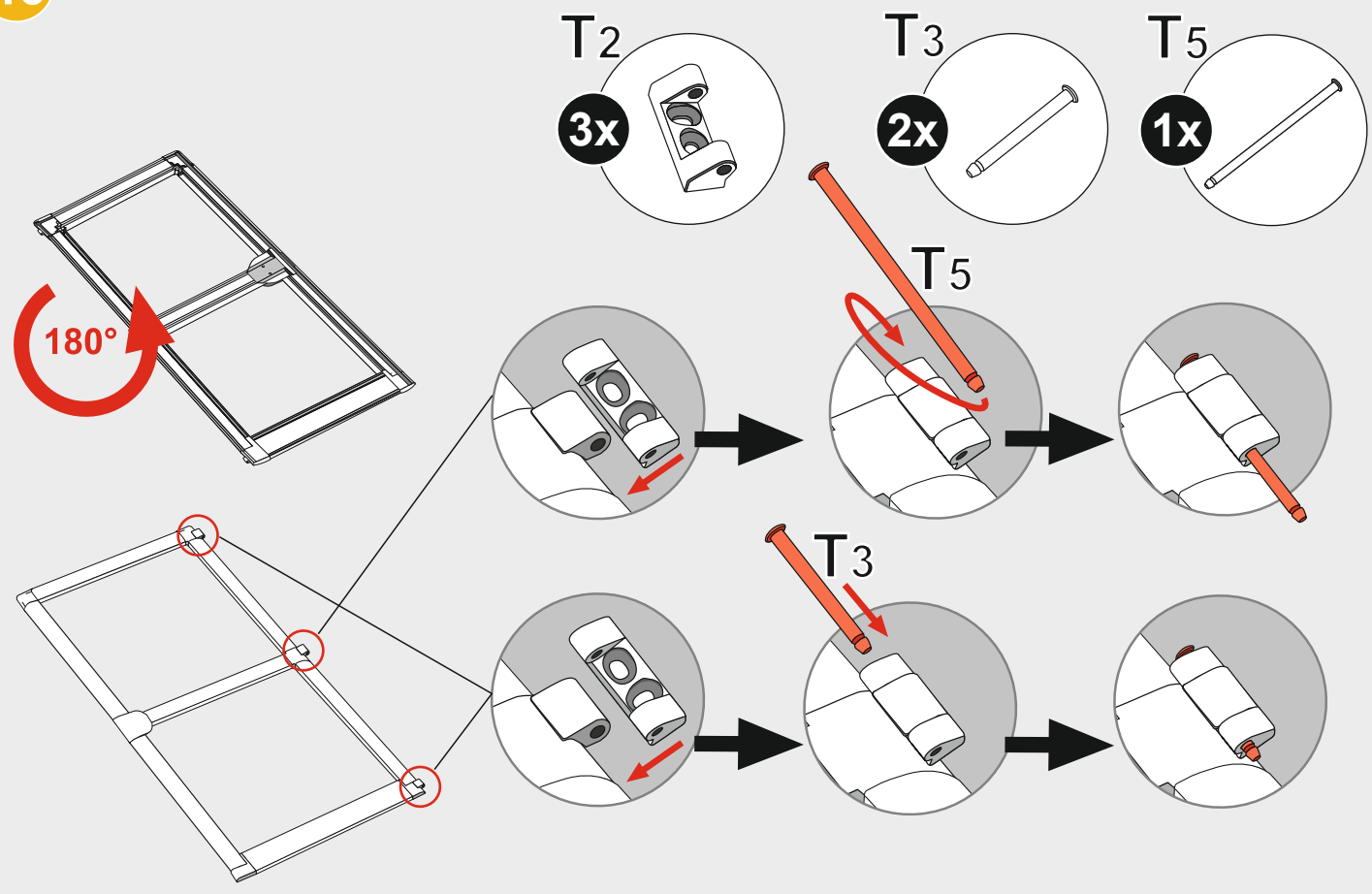

47

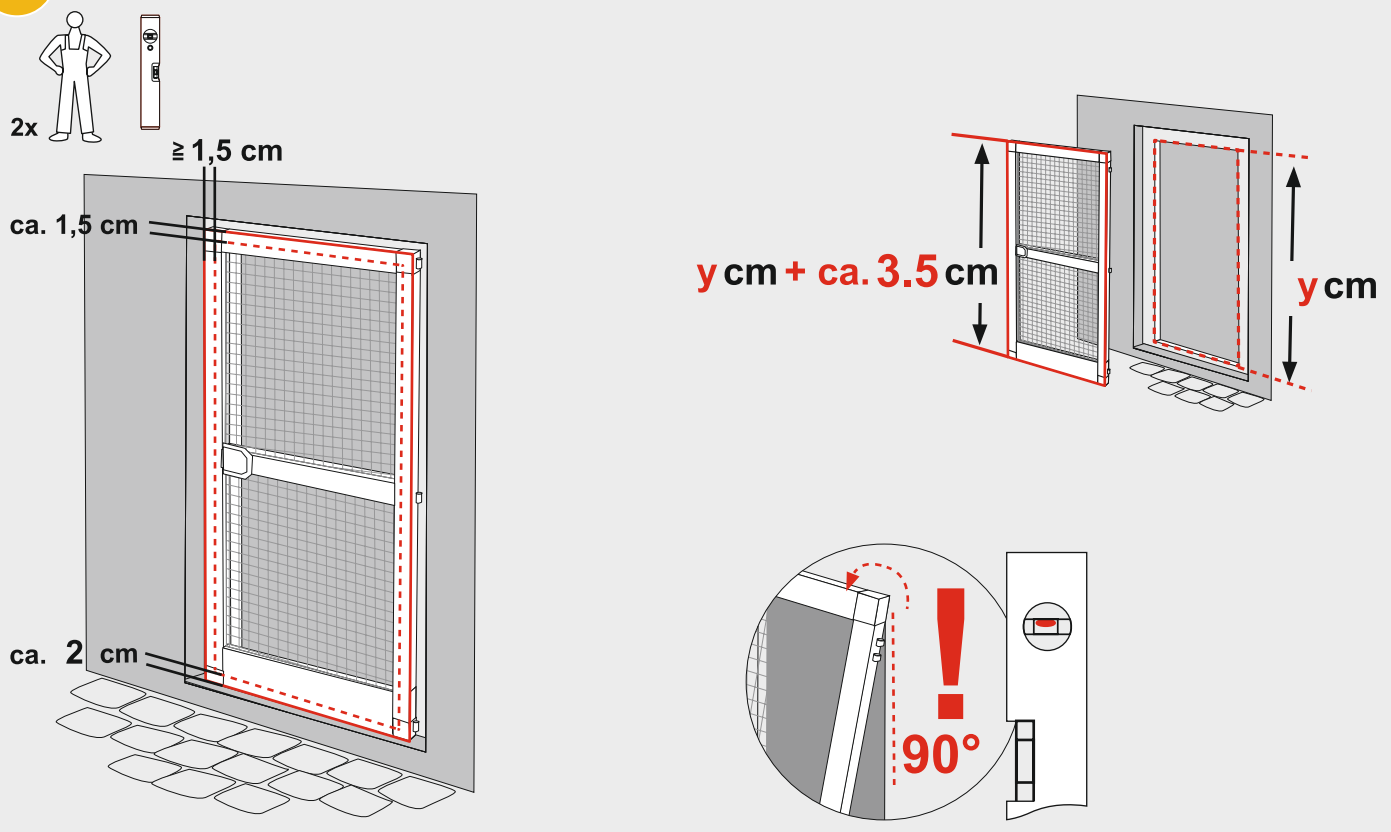

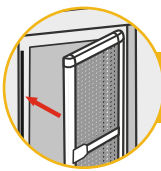

27 → 51

48

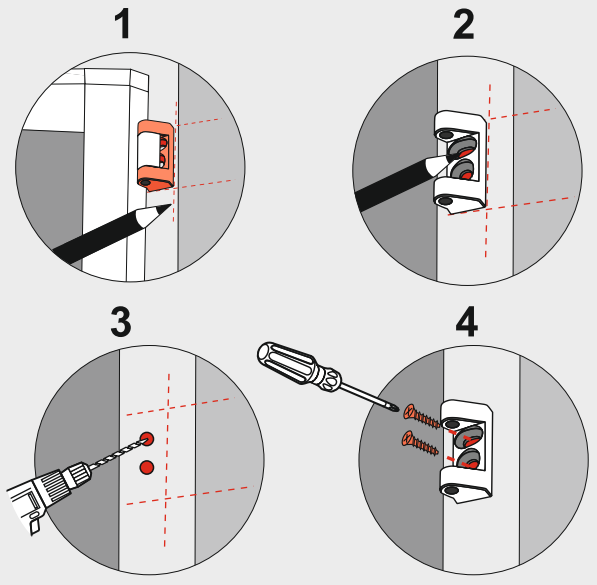
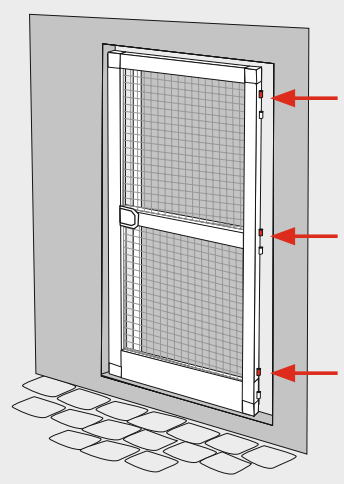
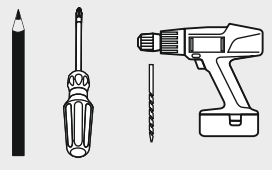

49

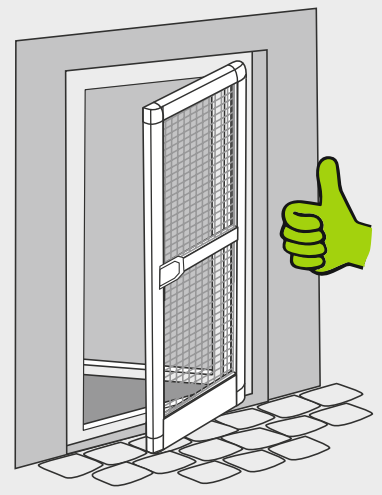
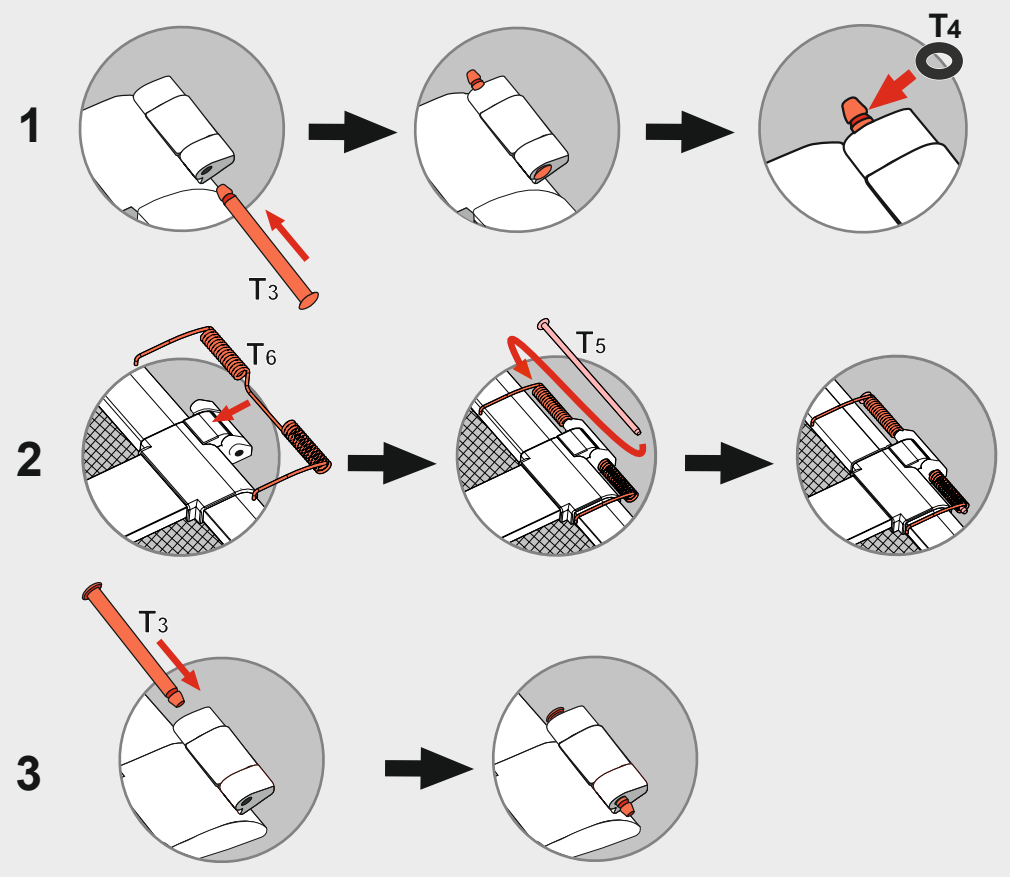
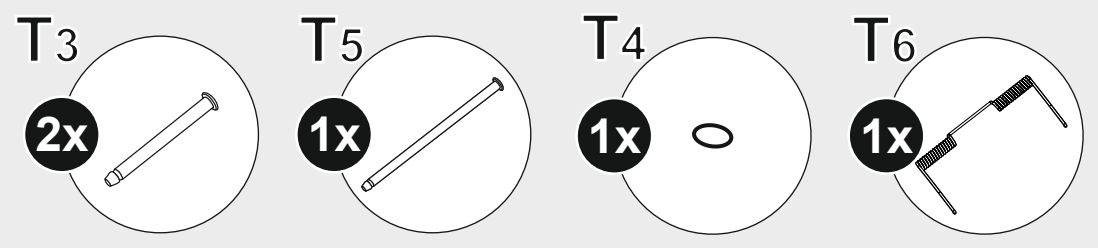
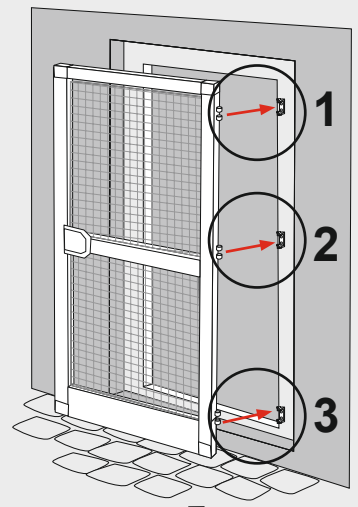

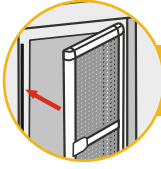

27 → 51

50

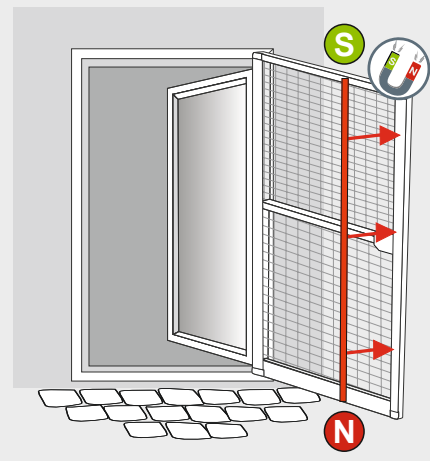
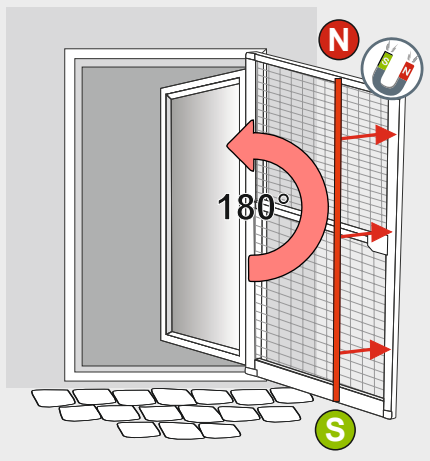
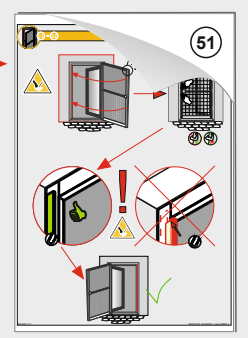
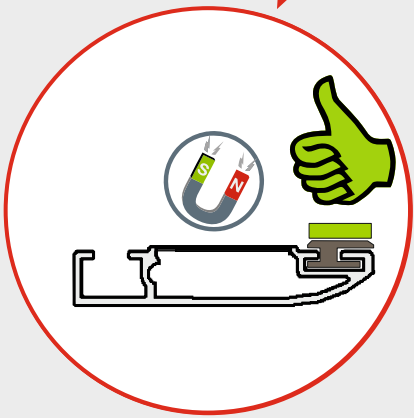
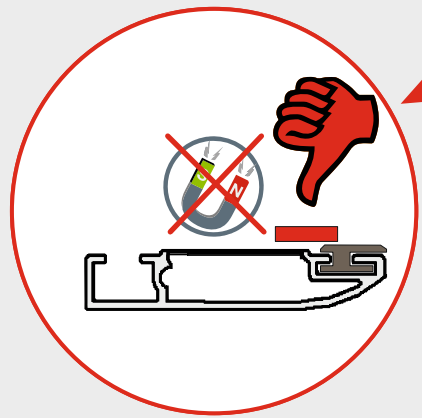
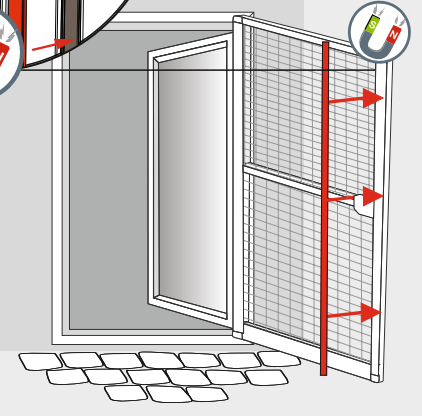
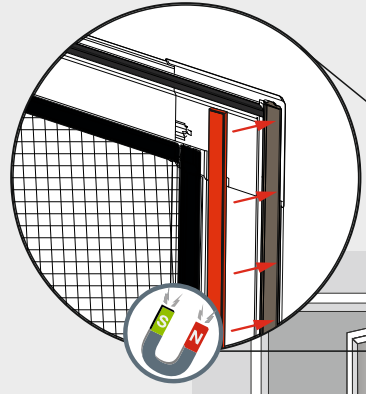
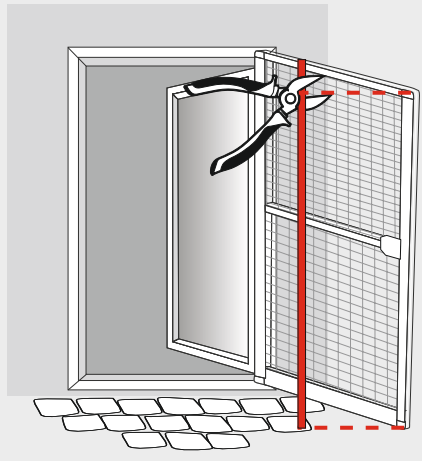
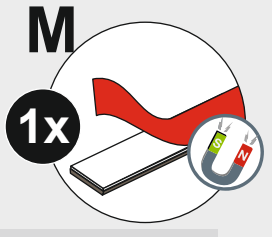

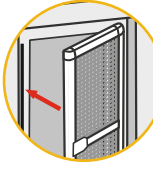

27 → 51

51

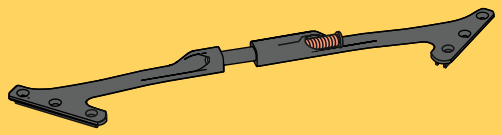
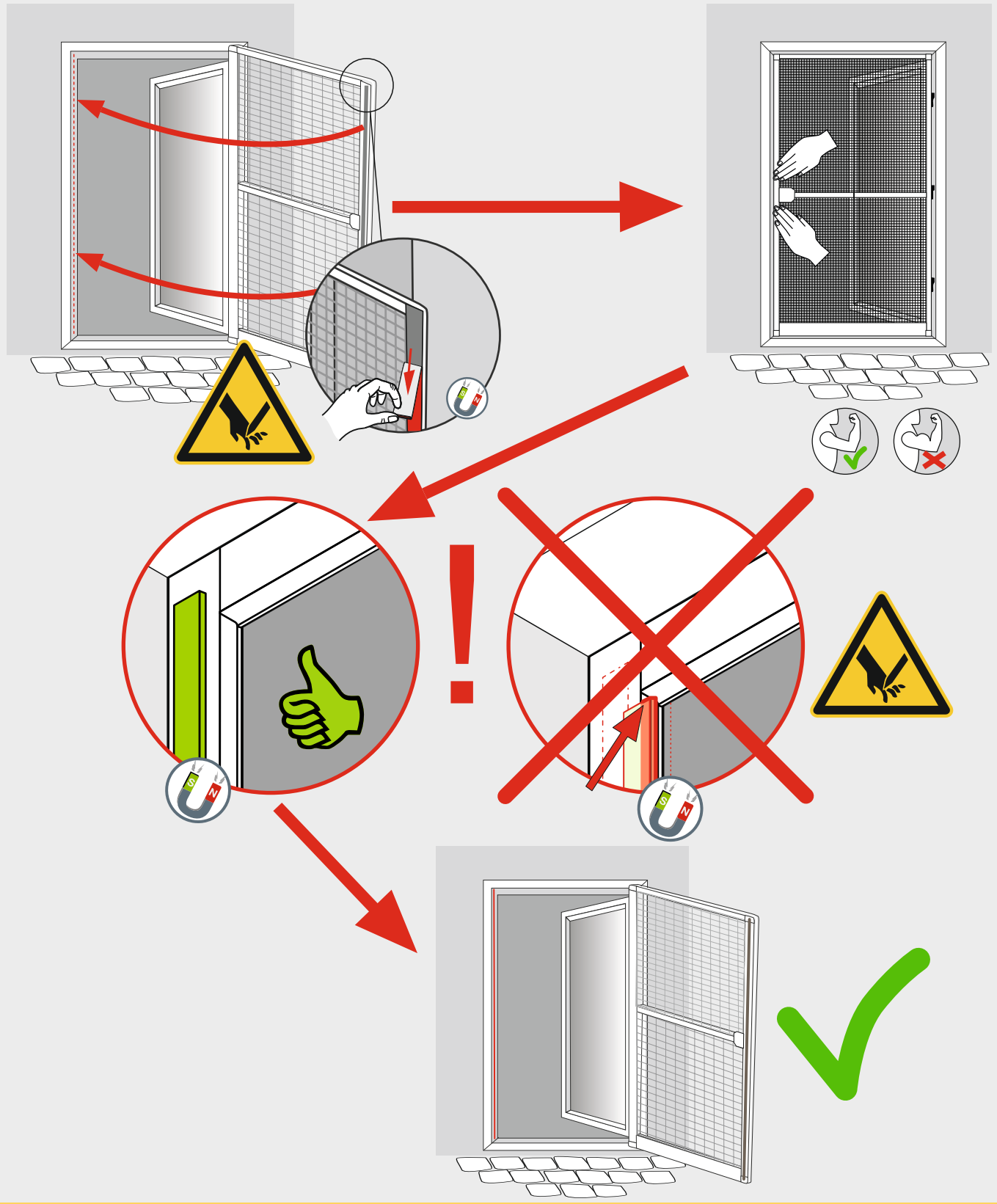

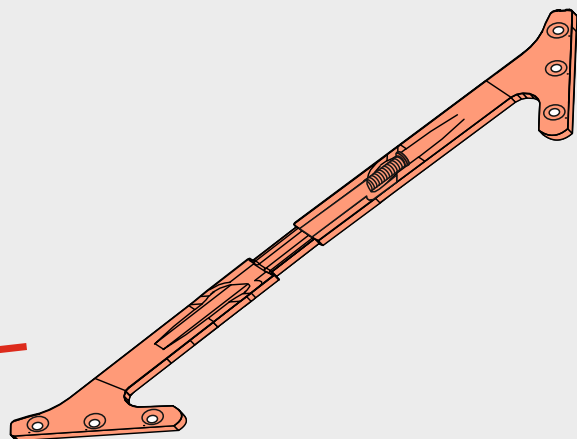
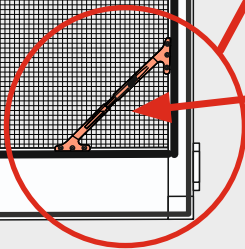
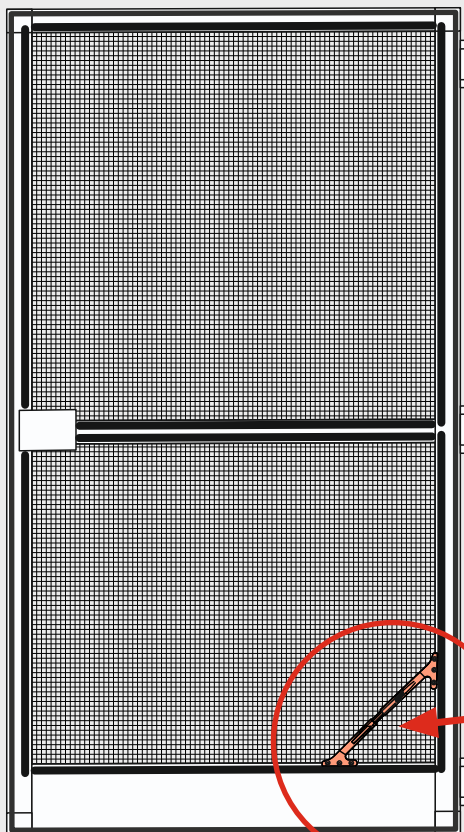
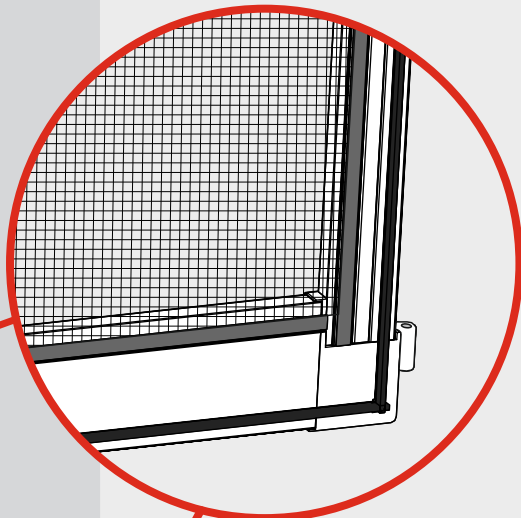
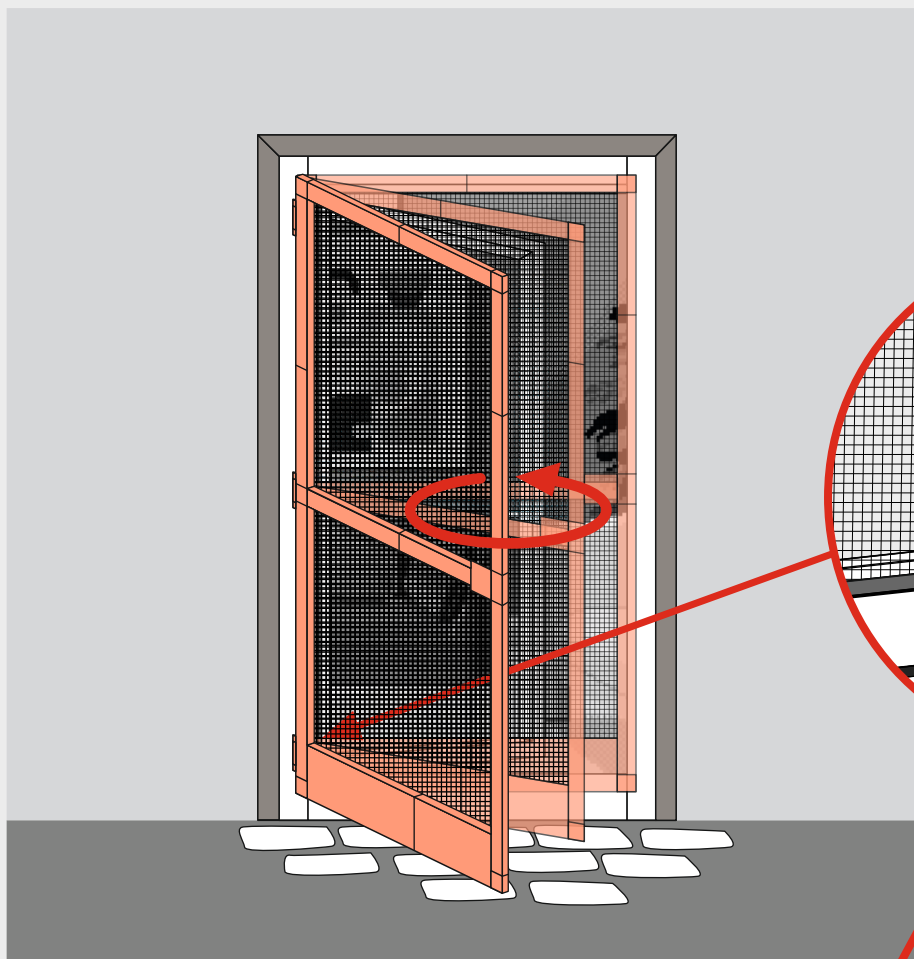



2

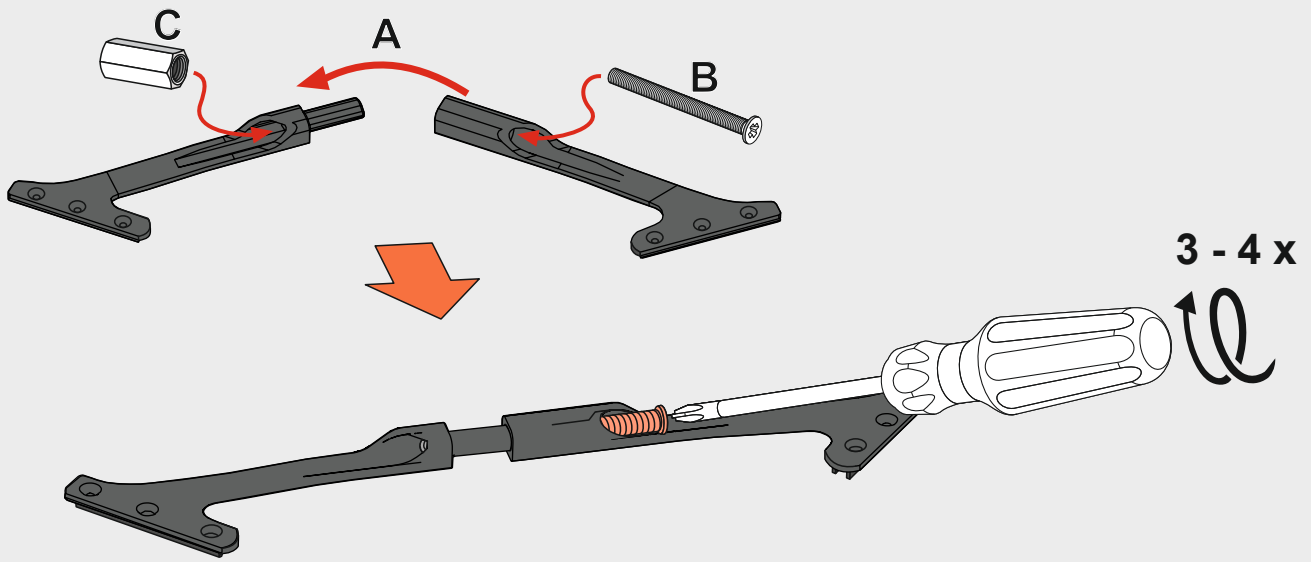
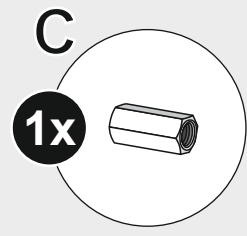
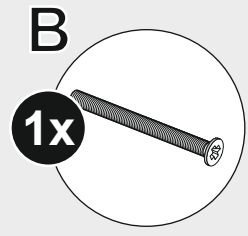
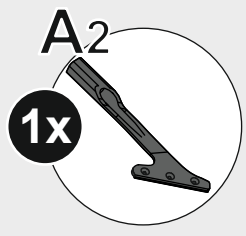
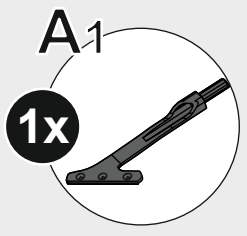

3

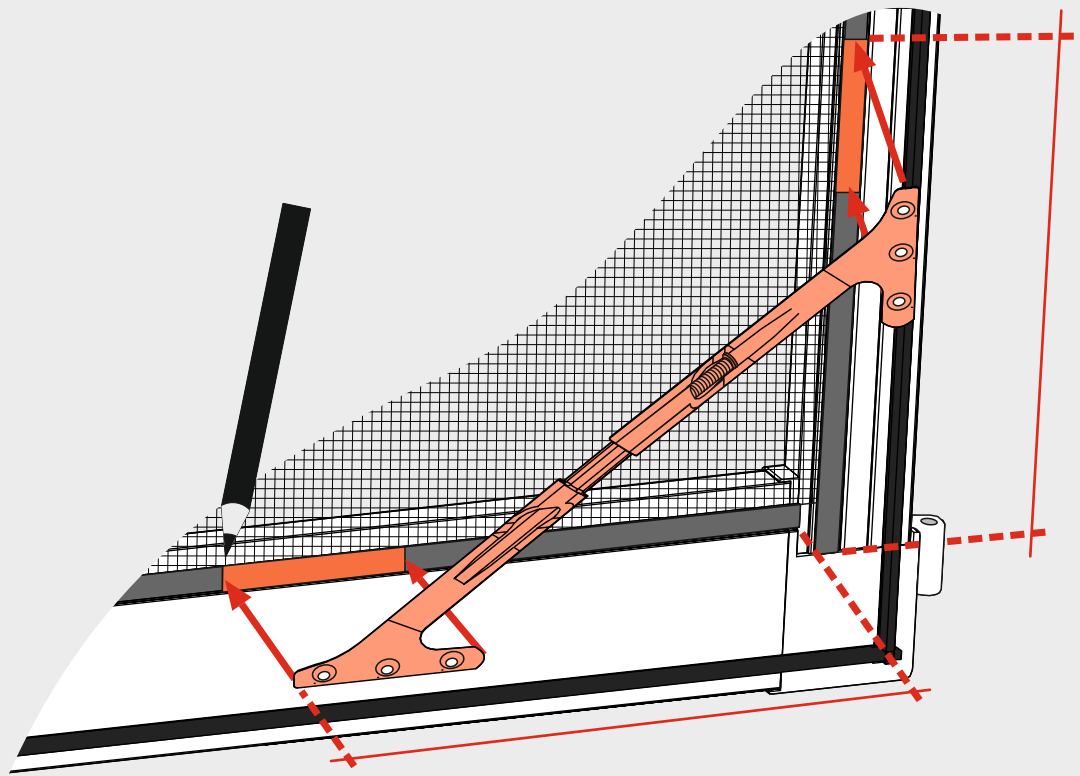

4

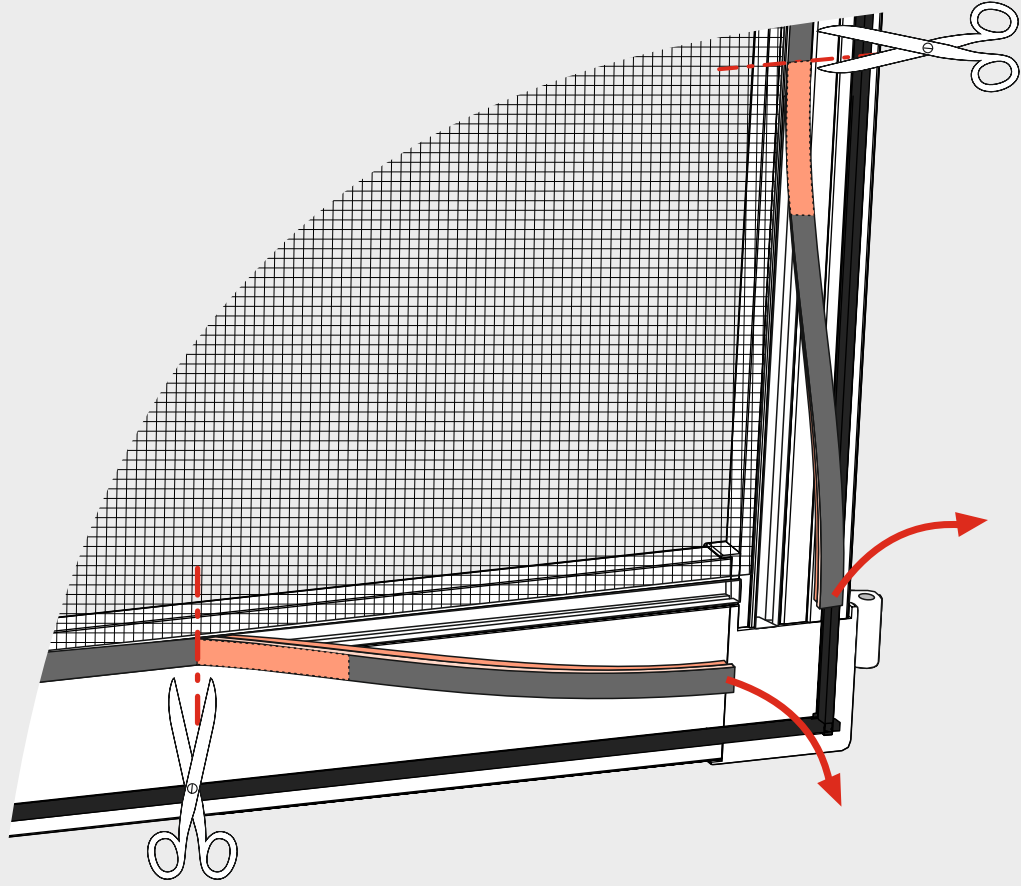
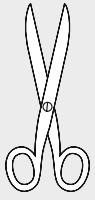

5

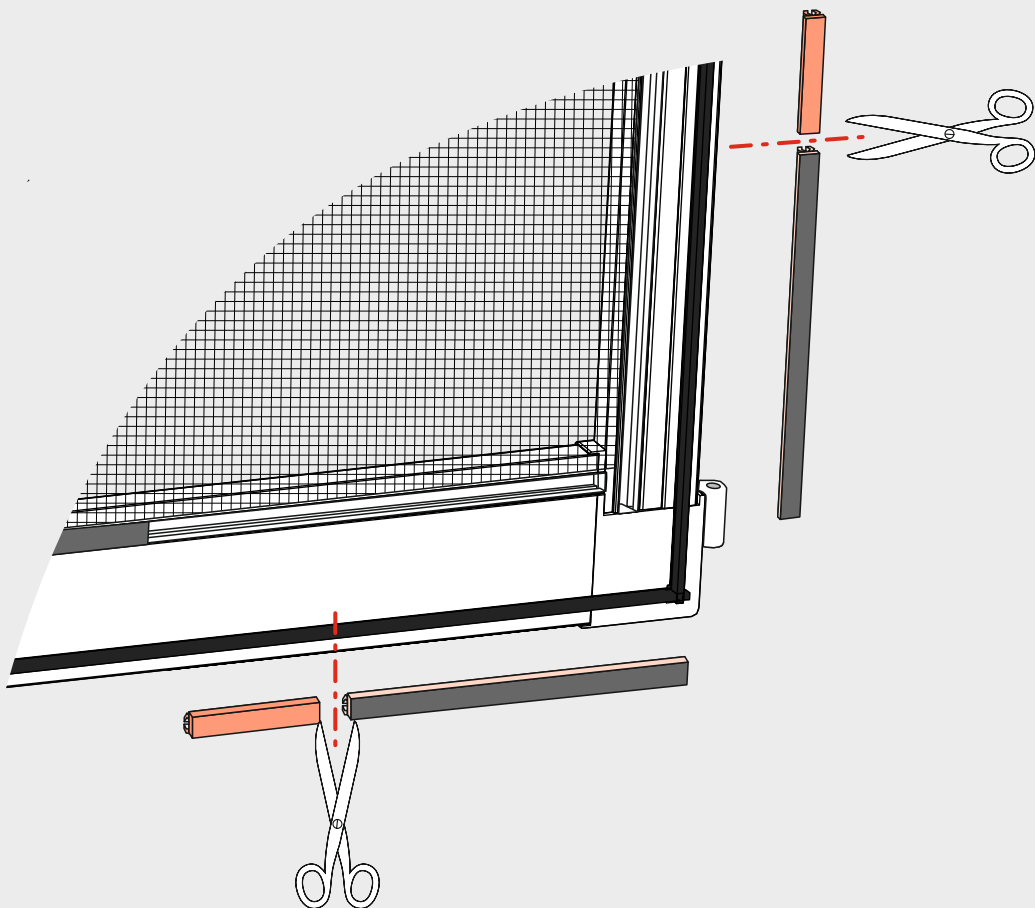
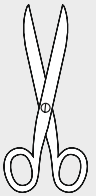



6

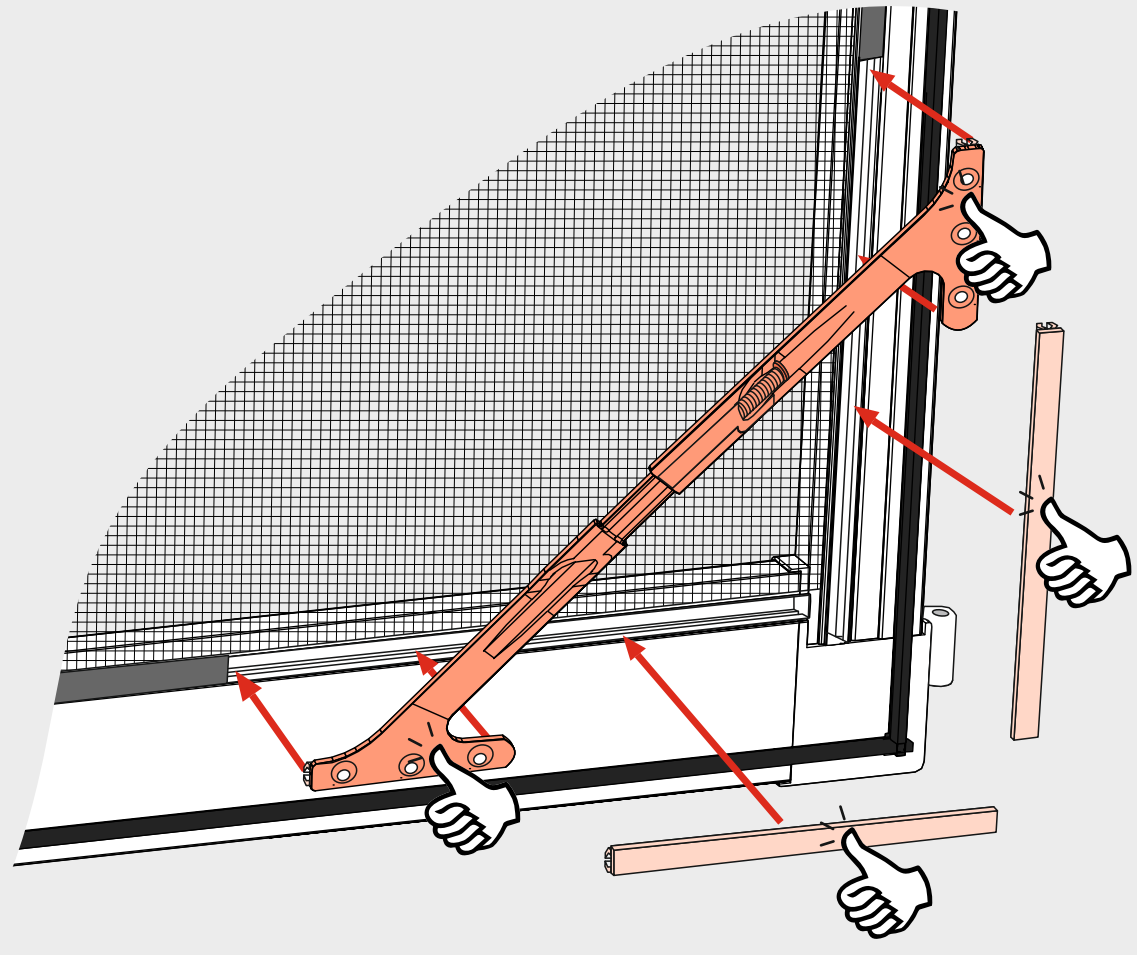

7

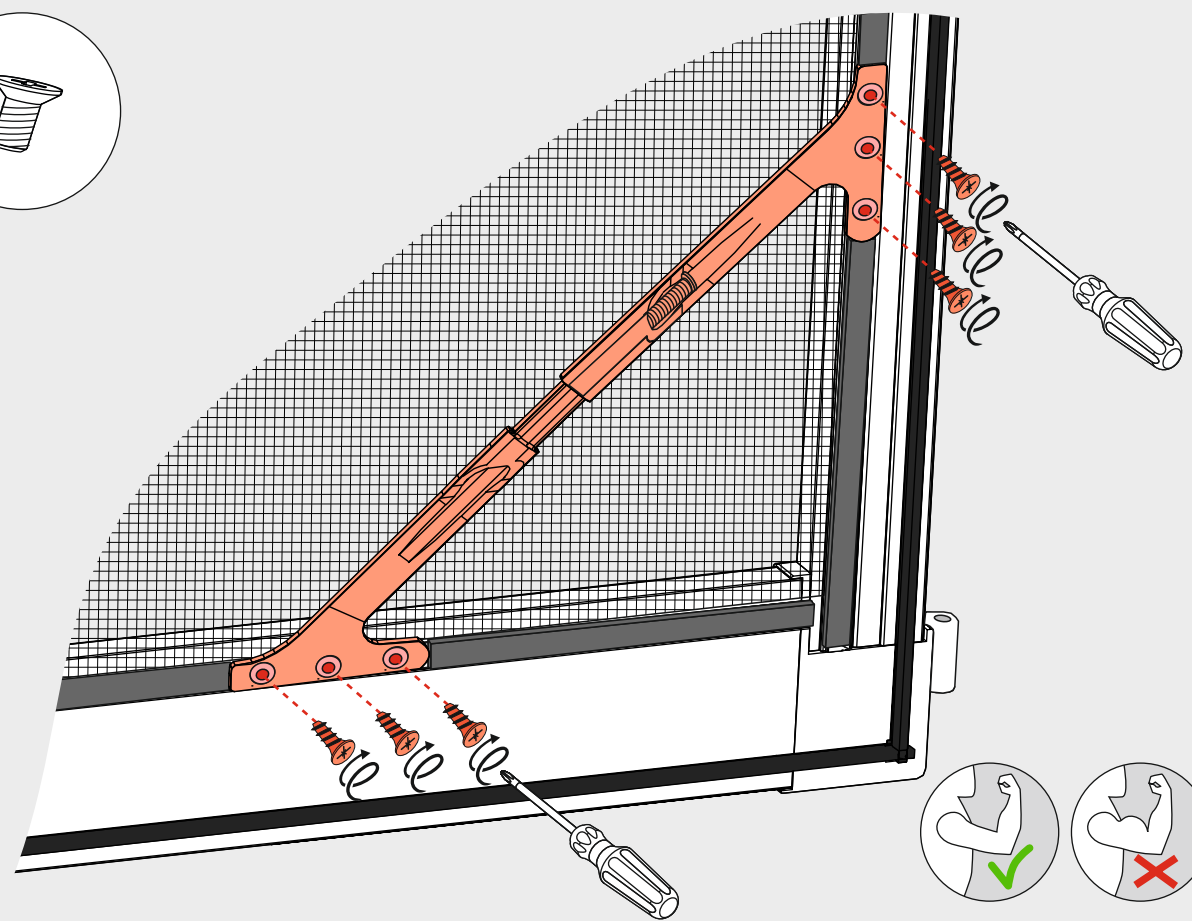
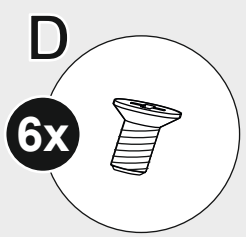
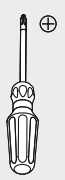



8

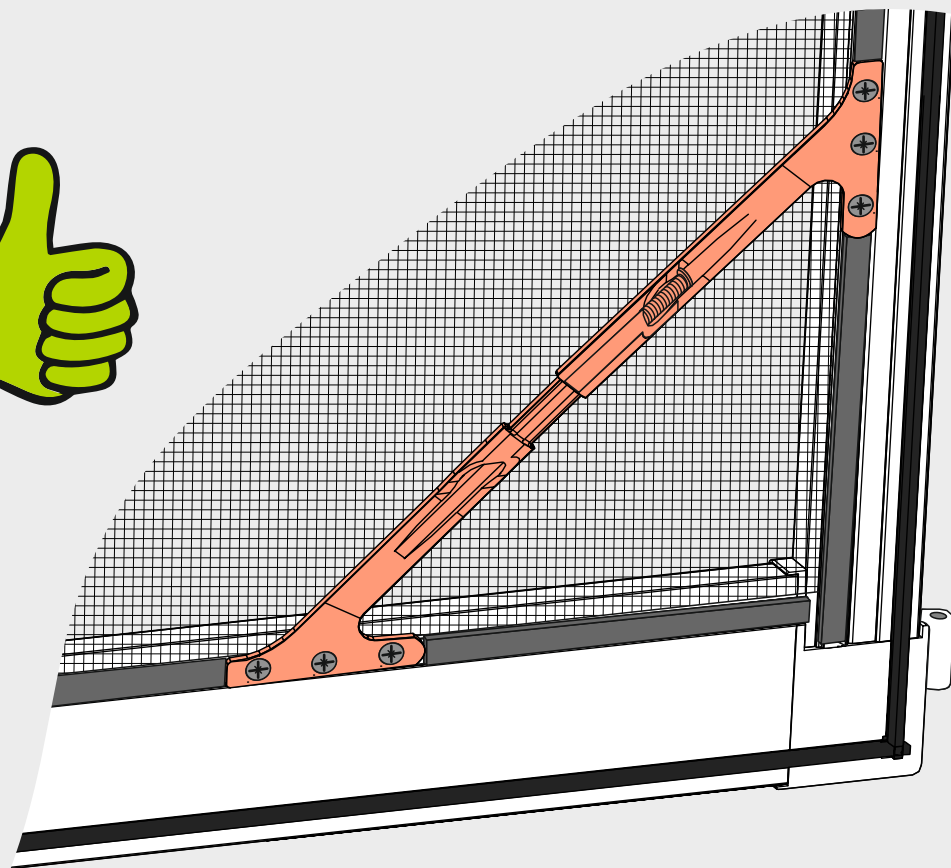

9



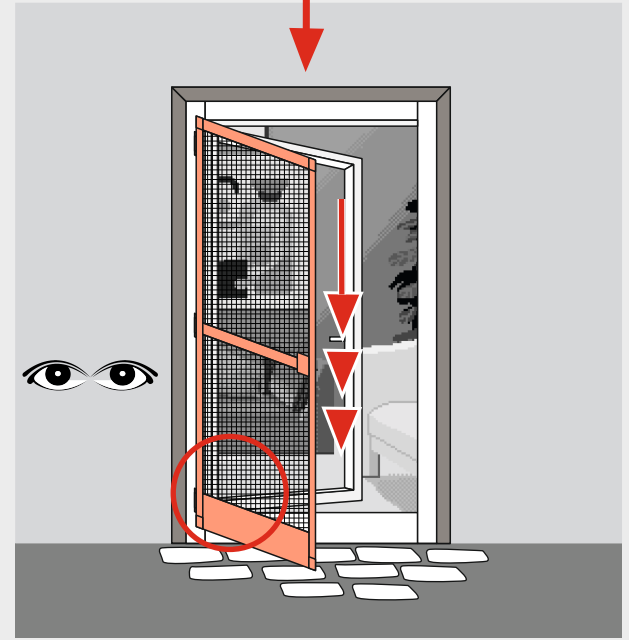
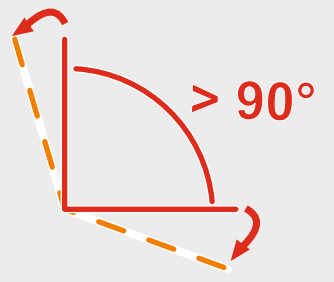
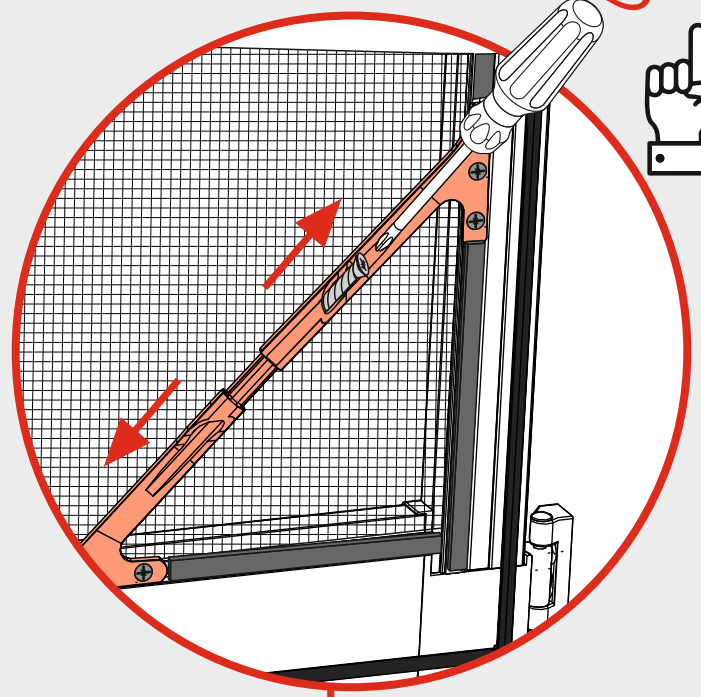
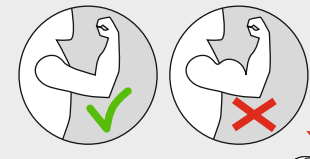
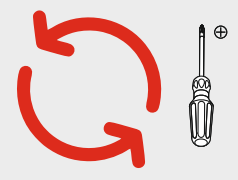
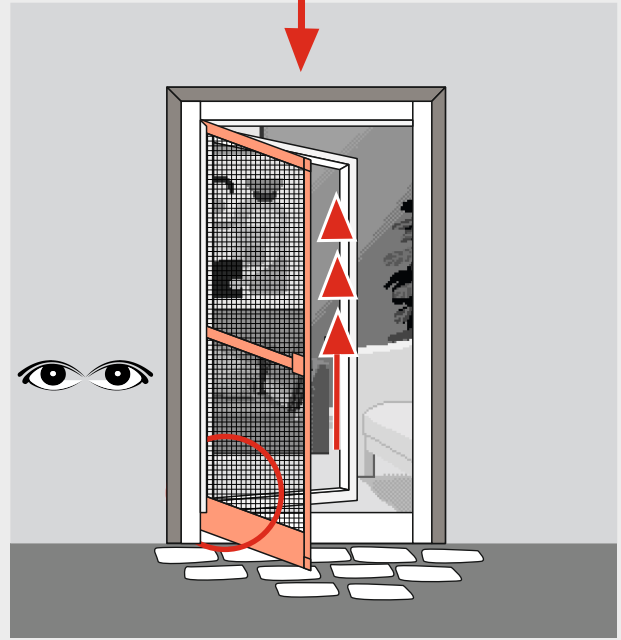
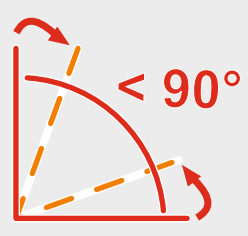
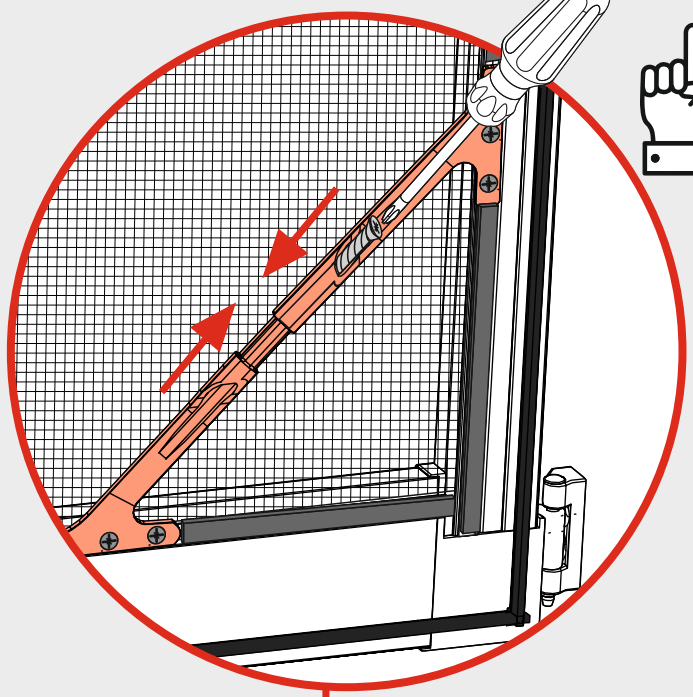
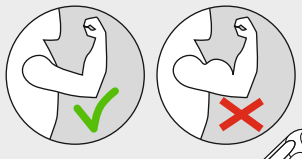
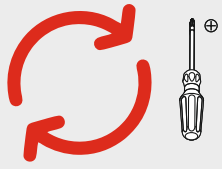
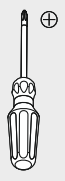



10

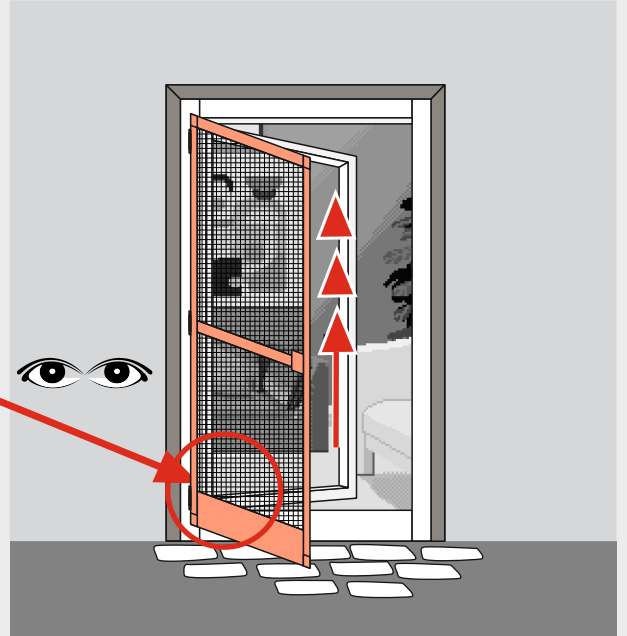
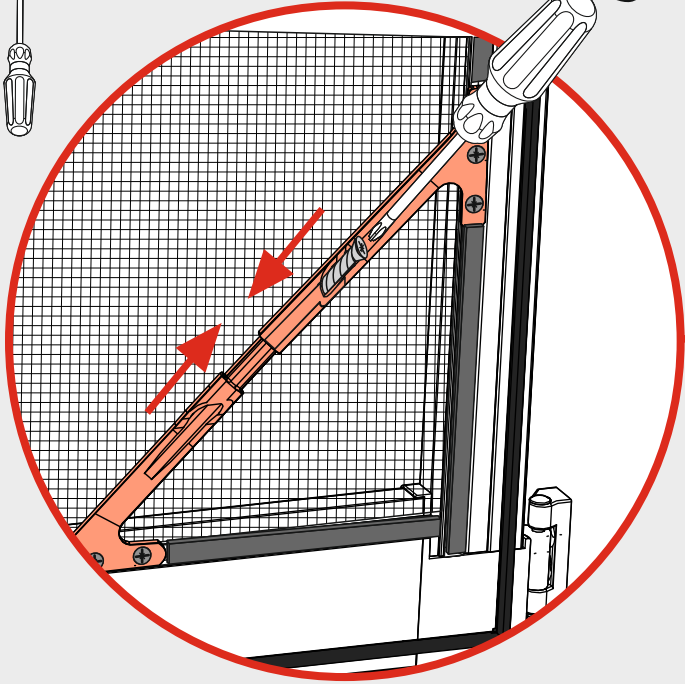
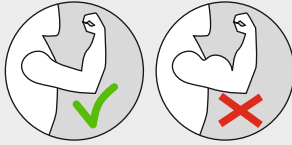

11

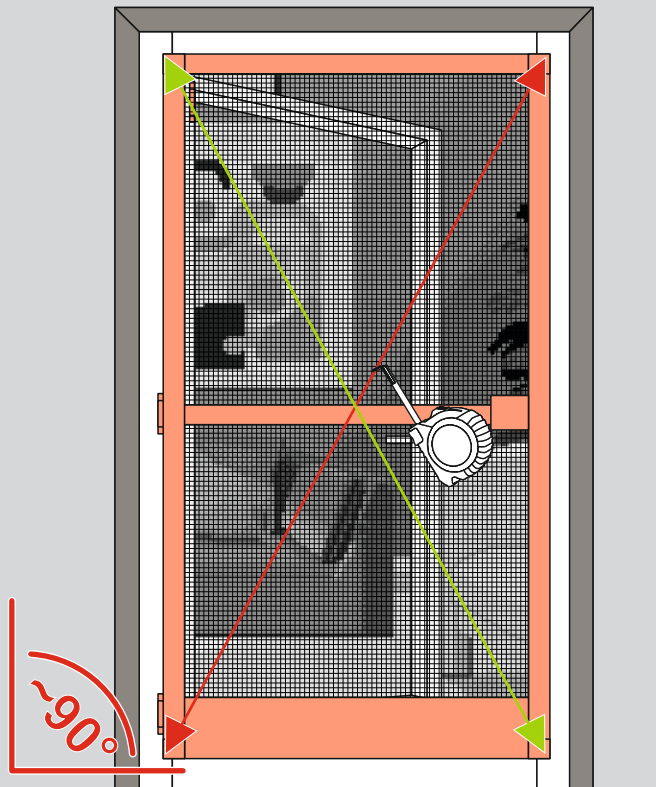
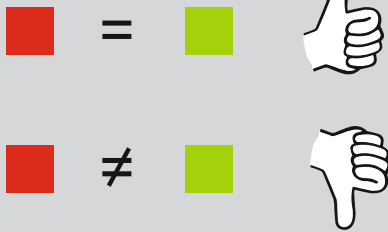
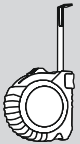

FR Si vous imprimez ce document, pensez à le trier !



LE TRI FACILE

