















MONTAGEANLEITUNG/INSTALLATION INSTRUCTIONS/MODE D'EMPLOI/MONTAGE INSTRUKTIE/ISTRUZIONI PER IL MONTAGGIO/INSTRUKCJA MONTAZU/MONTÁZNÍ NÁVOD/SZERELÉSI LEÍRÁS

<p>← 40 - 80 cm →</p>  2 x  2 x  4 x	<p>← 90 - 160 cm →</p>  3 x  3 x  6 x	<p>← 170 - 240 cm →</p>  4 x  4 x  8 x	<p> 2 x  1 x  1 x</p> <p> 4 x  2 x  1 x</p> 
--------------------------------------------------------------------------------------------------------------------------------------------------------------------------------------------------------------------------------------------------------------------------------------------	---------------------------------------------------------------------------------------------------------------------------------------------------------------------------------------------------------------------------------------------------------------------------------------------	------------------------------------------------------------------------------------------------------------------------------------------------------------------------------------------------------------------------------------------------------------------------------------------------	---------------------------------------------------------------------------------------------------------------------------------------------------------------------------------------------------------------------------------------------------------------------------------------------------------------------------------------------------------------------------------------------------------------------------------------------------------------------------------------------------------------------------------------------------------------------------------------------------------------------------------------------------------------



- (GB) To pull up or let down the venetian blind the slat must be in open position
- (D) Die Jalousie nur bei geöffneten Lamellen herablassen/aufziehen.
- (F) Abaisser/relever la jalousie uniquement lorsque les lamelles sont ouvertes.
- (I) Abbassare/alzare le veneziane sempre con le lamelle aperte.
- (NL) De jaloezie enkel met geopende lamellen neerlaten/ophalen.
- (S) Dra bara upp eller ner persiennen när lamellerna är öppna.
- (CZ) žaluzie spouštějte a vytahujte pouze v otevřené poloze lamel.
- (SK) žalúzie spúšťajte a vyťahujte iba v otvorenej pozícii.
- (RO) Jaluzeaua trebuie acționată sus-jos numai cu lamelele deschise.

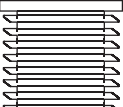
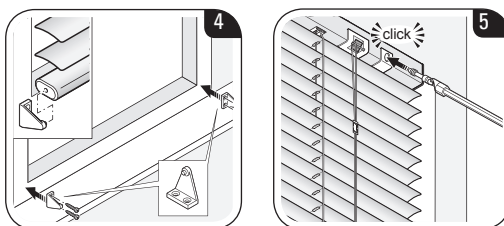
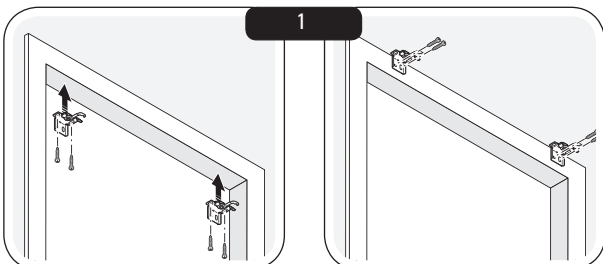
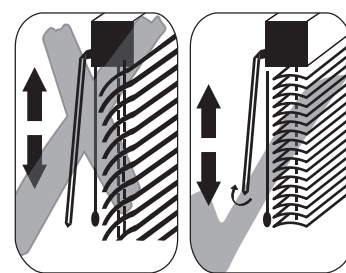
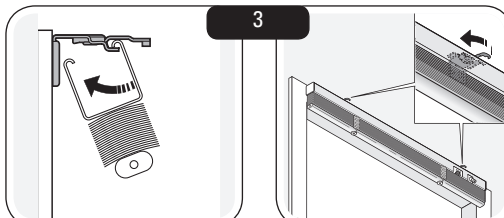
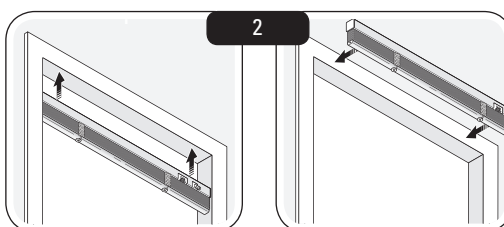
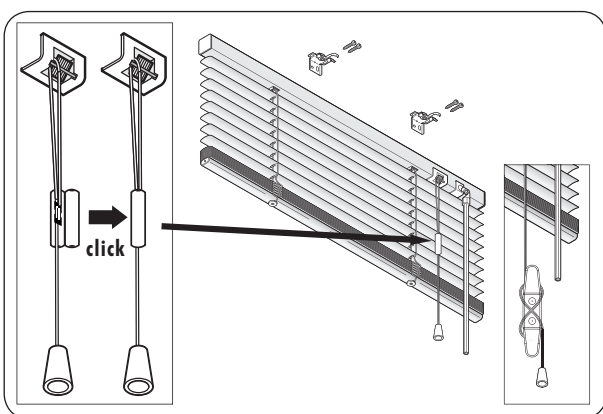
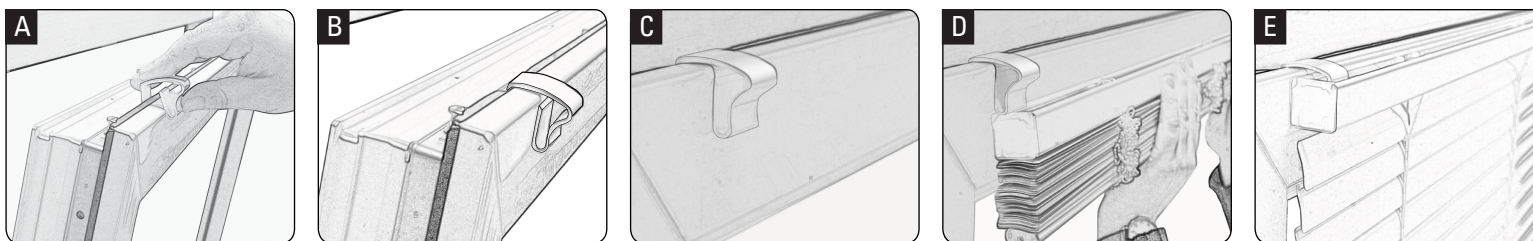
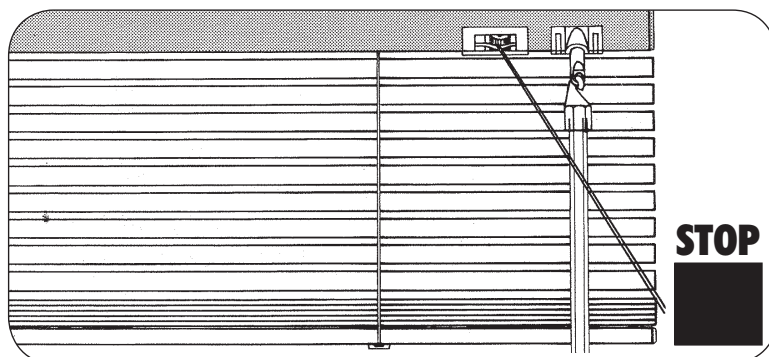
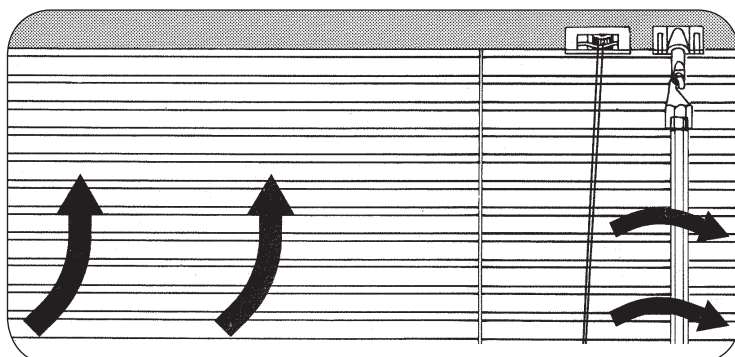
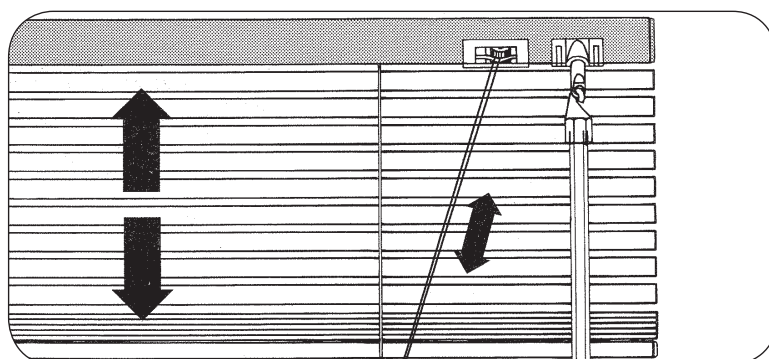
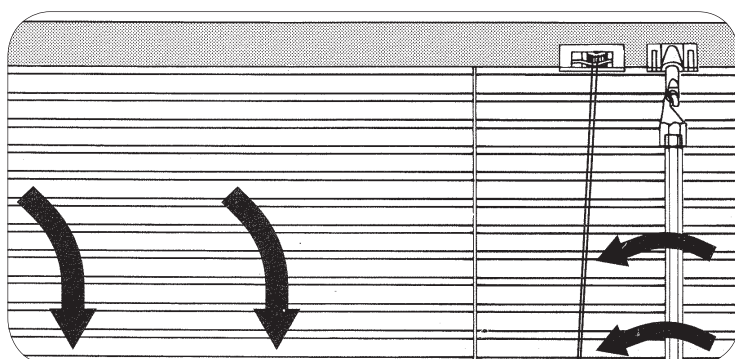

KÜRZANLEITUNG / SHORT INSTRUCTIONS / NOTICE D' EMPLOI / BREVI ISTRUZIONI / INKORT INSTRUKTIE / WPROWADZENIE / KRÁTKÝ NÁVOD / RÖVID LEIRÁS

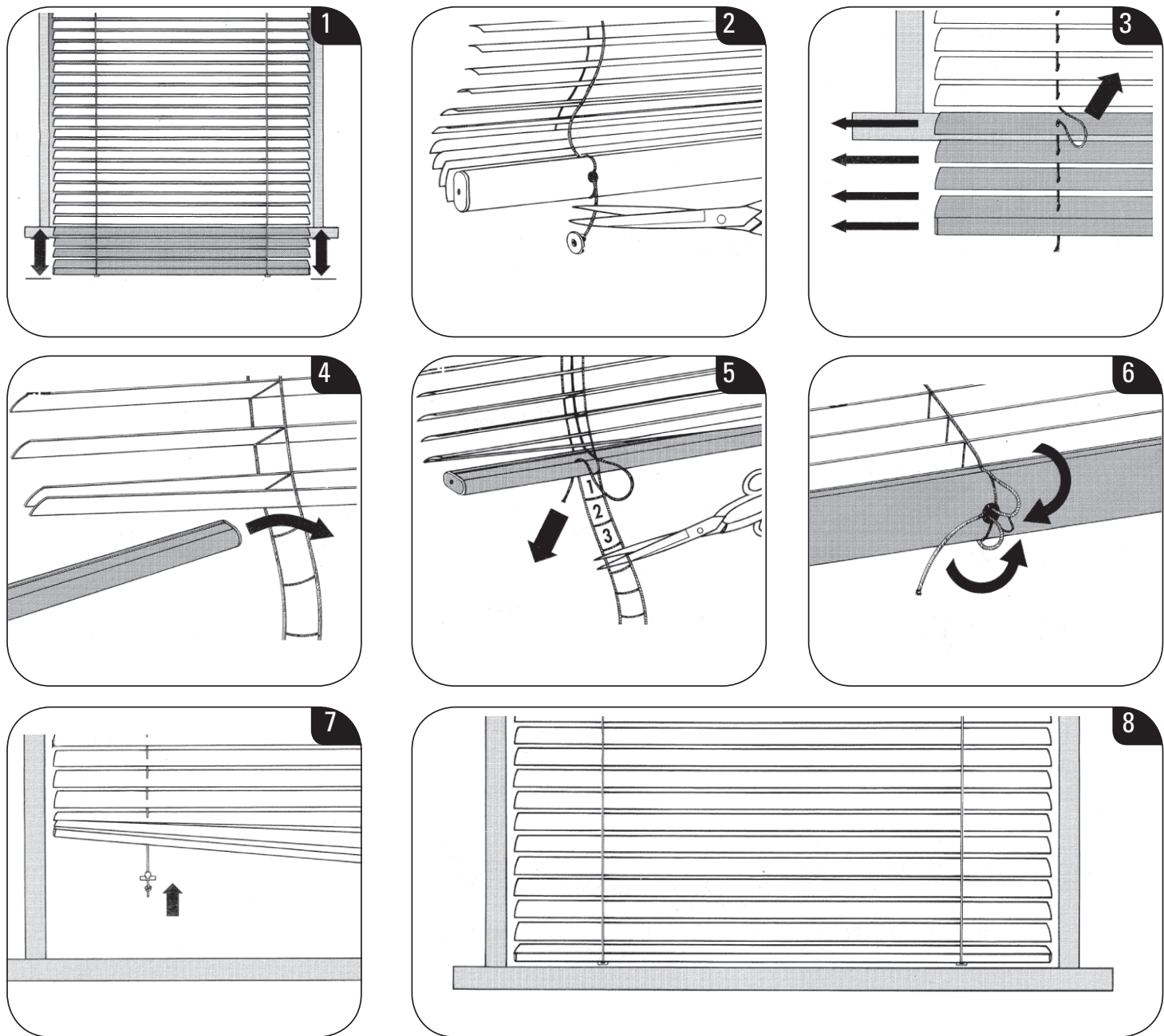

150 cm

Achtung!
 Kleine Kinder können sich in den Schlingen von Schnüren, Ketten oder Gurten zum Ziehen sowie in Schnüren zur Betätigung von Fensterabdeckungen strangulieren. Schnüre sind aus der Reichweite von Kindern zu halten, um Strangulierung und Verwicklung zu vermeiden. Sie können sich ebenfalls um den Hals wickeln.
 Betten, Kinderbetten und Möbel sind entfernt von Schnüren für Fensterabdeckungen aufzustellen. Binden Sie Schnüre nicht zusammen. Stellen Sie sicher, dass sich Schnüre nicht verdrillen und eine Schlinge bilden.
 Die enthaltenen Sicherheitsvorrichtungen sind gemäß der Montageanweisung auf den Geräten zu montieren und zu verwenden, um das Unfallrisiko zu minimieren. Gemäß EN 13120.

Warning!
 Strangulation risk for small children will exist if they should get tangled in slings from cords, chains or straps for pulling the controls of the window covering. Cords are to be kept out of the reach of children, in order to avoid strangulation and entanglement. They could possibly get wrapped around the neck.
 Beds, cribs, and furniture are to be located away from cords for window coverings. Do not tie cords together. Make sure that cords do not twist and create a sling. Install and use the included safety devices according to the installation instructions on these devices to reduce possibility of such an accident.
 According to EN 13120.